



## JOINTS



*GEL CONNECTION  
PRE-FILLED  
FOR CASTING  
INJECTION  
SYSTEM PLUS  
SYSTEM FAST RP  
HEAT-SHRINK*



## FILLERS



*GEL  
GELGUM  
RUBBER  
RESIN*



## IP68 JOINTING BOXES



*POWER KIT  
GEL LEADER PACK  
MAGIC BOX  
J-BOX*

page 6

74

94

# Low Voltage



## HEAT-SHRINK



THIN-WALL  
MEDIUM-WALL  
HEAVY-WALL  
WRAP AROUND  
POLE PROTECTION  
CAPS  
MOULDED PARTS

106



## INSULATION TAPES



PVC  
SELF-AMALGAMATING  
SPECIAL

116



## CABLE PULLERS and LUBRICANTS



LUBRICANTS  
NYLON PULLERS  
POLYESTER PULLERS  
SELF-STARTING  
PULLERS  
ACCESSORIES

122



## FIRE STOP BARRIERS



BAGS  
PANELS  
COLLARS  
PUTTY  
FOAM  
TUBULAR  
COMPOUND  
COVERINGS

128



## SPECIALS



GALACTIC LINE  
RUBBER LINE  
INDISPENSABLE

136



# JOINTS

## Gel Connection

PRE-FILLED GEL ACCESSORIES

page  
8

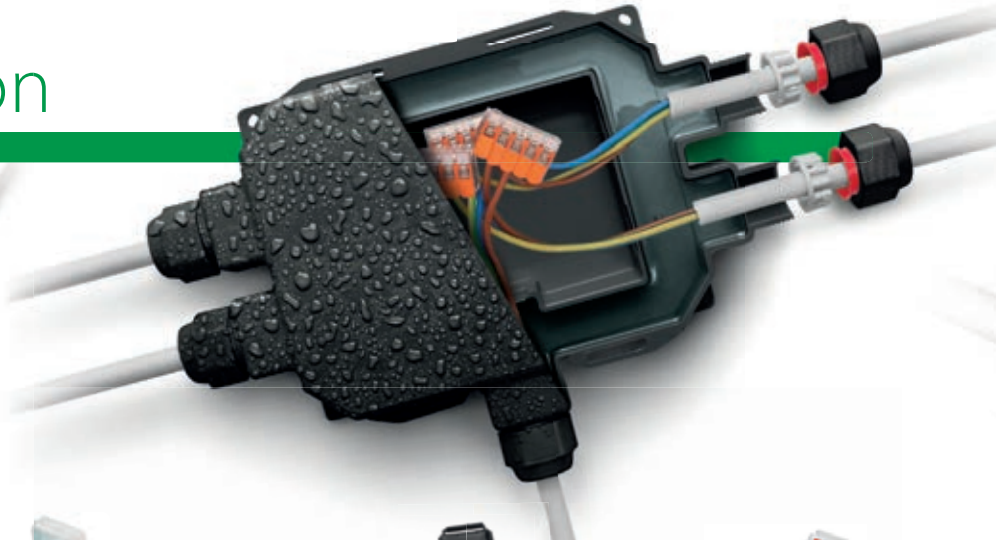

**IPX8**  
OFFICIALLY  
TESTED



Happy Line



Gel Box Line



Gel Cover Line



Nano Line

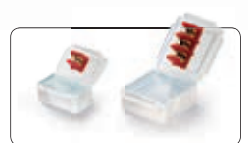

Bravo Line

**IP69K**  
OFFICIALLY  
TESTED

**IP68**  
OFFICIALLY  
TESTED



Little Joint Line **NEW**



Fox Box IP68 **NEW**



Ready Box IP68

## For casting

WITH CASTING FILLER

page  
48



Magic Power Joint



Magic Joint



Magic Joint Fire



Rubber Joint



Raycast

**Ray  
Tech**



# Pre-filled

JOINTS FILLED WITH ALREADY CROSS-LINKED GEL

page  
34

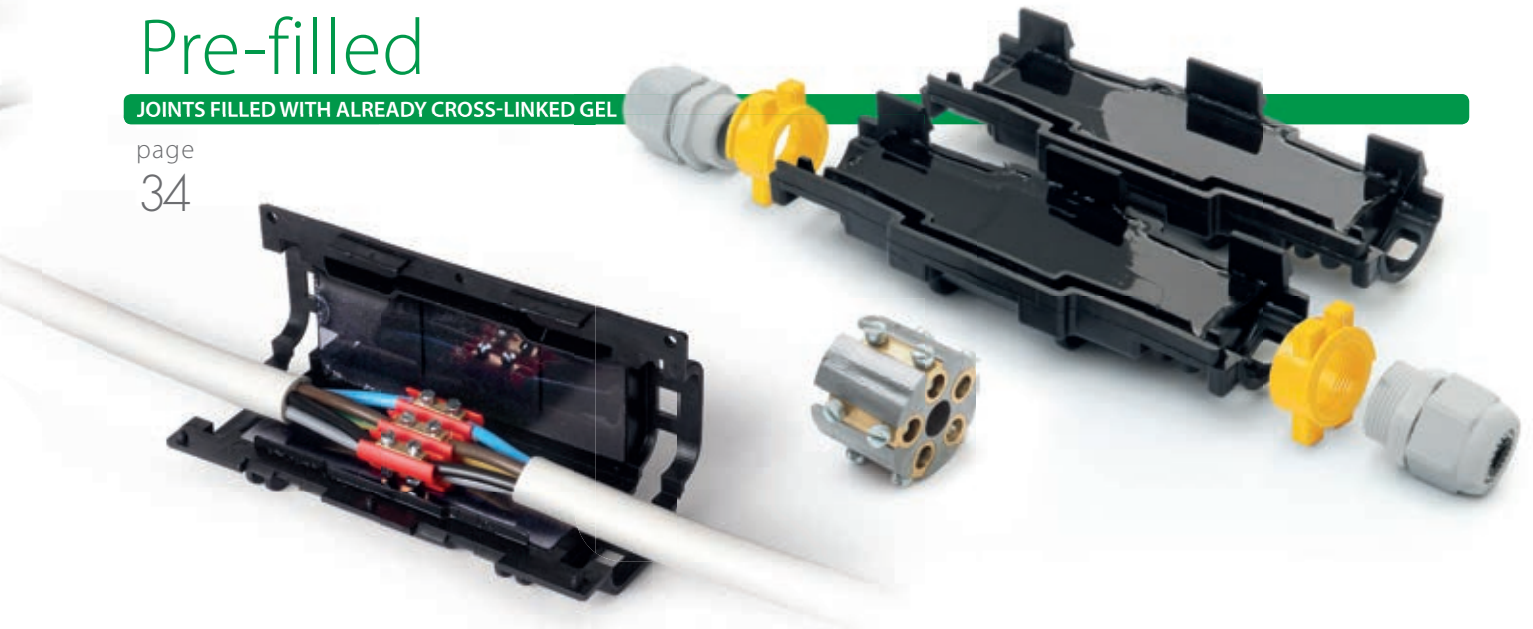

Integrated connection



Rapid Joint IP68



Mini Rapid Joint IP68



Super Klik



King Joint

Free connection



Rapid Joint



Klik Fire

# Injection

WITH CARTRIDGE FILLER

page  
66



Wonder Joint

# Heat-shrink

HEAT-SHRINK JOINTS

page  
68

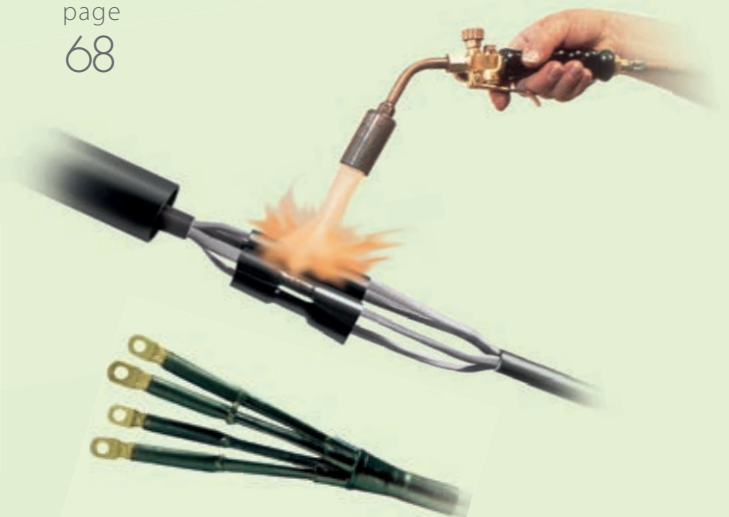





# Happy

The revolutionary mini accessories with 3 entrances, pre-filled with gel and suitable for submersible installations (IPX8).

Designed in 3 dimensions to rapidly insulate and seal the most commonly used connectors. The 3 entrances not only guarantee the extreme flexibility in the range of these products but also by the housing accepting a wide variety of connectors.

**Electrical performance:**  
CEI EN 50393 as applicable  
(testing under water head  
of the accessory installed in a box)

**Gel:** UL 94-HB 

Operating temperature 

Installation temperature:   
-40°C / +50°C

Fully submersible 

Can be used underground 

**IPX8**  
OFFICIALLY  
TESTED | **IMQ**

- Extremely versatile - Ready to use - Re-enterable
- For rigid or flexible insulated wires up to 4 mm<sup>2</sup>
- Pre-filled with gel, non toxic and no shelf life
- Small compact and robust
- Halogen free
- UV resistant

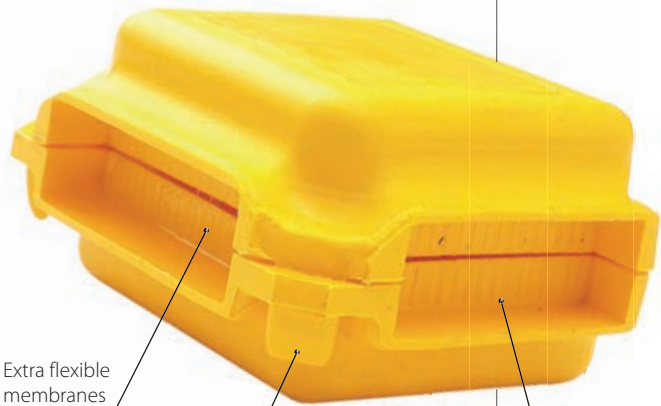

Extra flexible membranes

Safety closing system

Extra flexible membranes

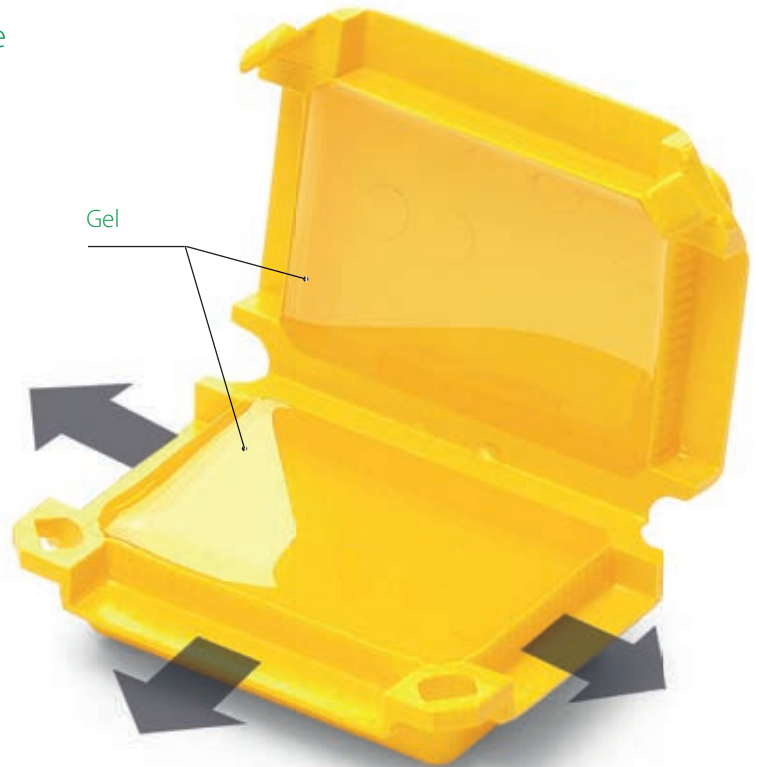

Gel

Configuration examples

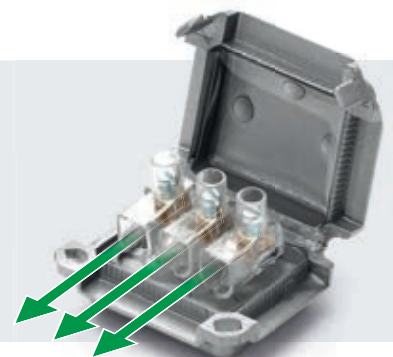
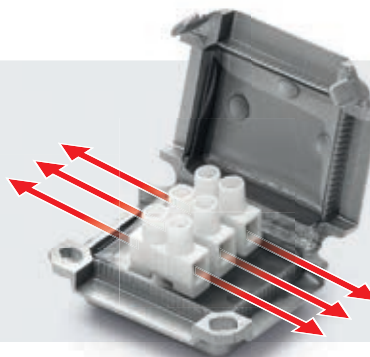



## Happy 0

Product	Pieces	Color	Description	A x B x C (mm)
Happy 0	x 4	●	Blister	41 x 28 x 19
Happy 0 Box12	x 12	○	Box	



IDEAL FOR (or similar):

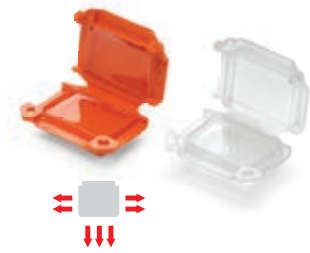

## Happy 1

Product	Pieces	Color	Description	A x B x C (mm)
Happy 1	x 2	●	Blister	45 x 37 x 24
Happy 1 Box10	x 10	○	Box	



IDEAL FOR (or similar):

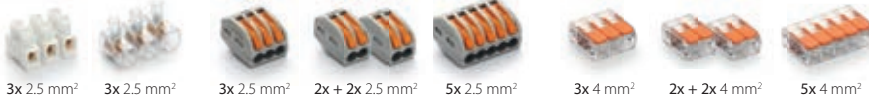

## Happy 2

Product	Pieces	Color	Description	A x B x C (mm)
Happy 2	x 1	●	Blister	53 x 39 x 24
Happy 2 Box7	x 7	○	Box	



IDEAL FOR (or similar):

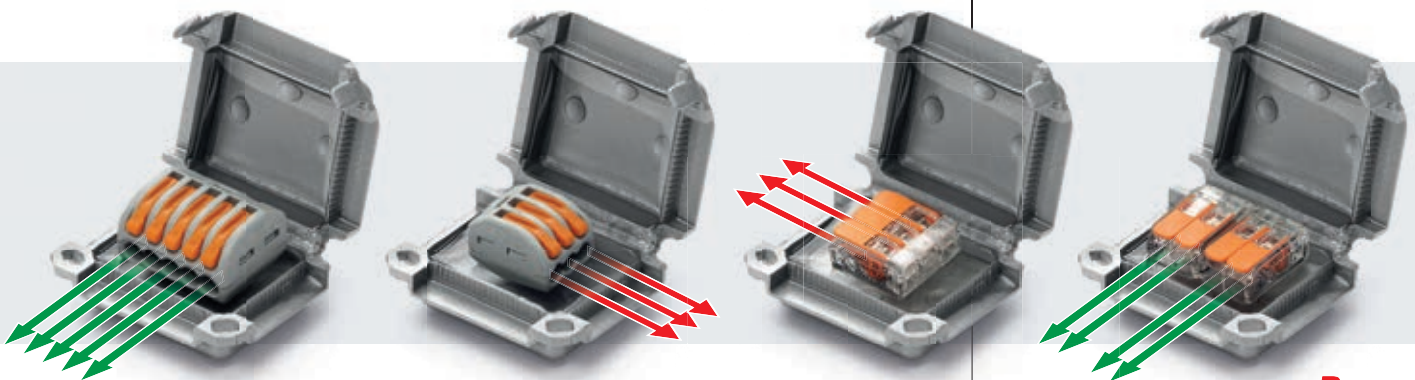
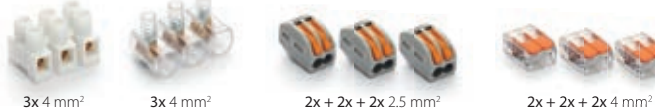





# Happy Joint

**Electrical performance:**  
CEI EN 50393 as applicable  
(testing under water head  
of the accessory installed in a box)

**Gel:** UL 94-HB 

Operating temperature 

Installation temperature:   
-40°C / +50°C

Fully submersible   
Can be used underground 

**IPX8**  
OFFICIALLY  
TESTED | **IMQ**

The revolutionary mini accessories with 3 entrances, pre-filled with gel and suitable for submersible installations (IPX8) complete with connectors.

- Extremely versatile - ready to use - re-enterable
- Small, compact and robust
- No need for tools
- Pre-filled with gel, non toxic and no shelf life
- Can energise immediately
- For straight and branch connections
- For rigid or flexible insulated wires up to 6 mm<sup>2</sup>
- Up to 5 conductors on one phase or up to two conductors on two or three phases
- Halogen free
- UV resistant

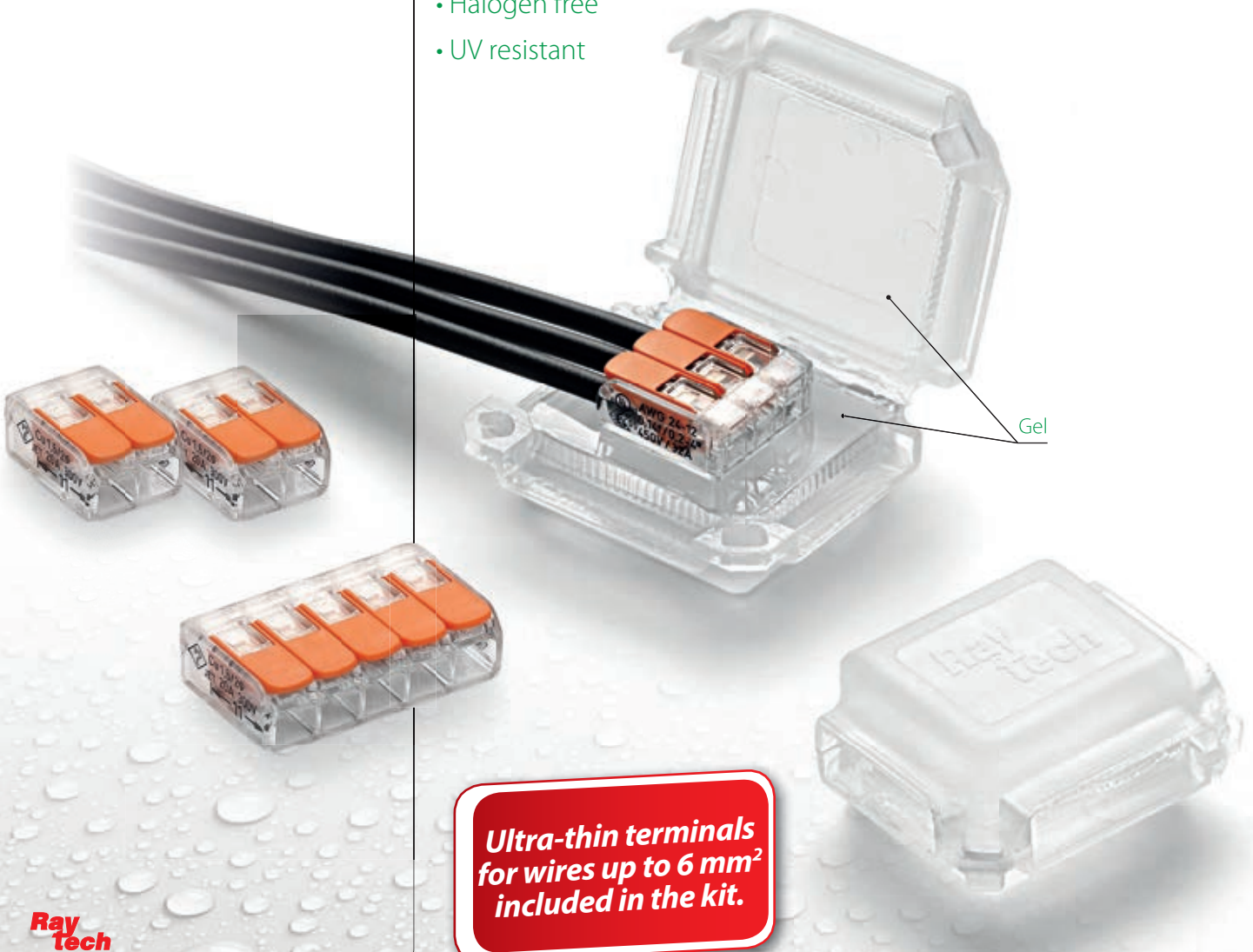

**Ultra-thin terminals  
for wires up to 6 mm<sup>2</sup>  
included in the kit.**



## Happy Joint 3



Product	Formation and wires cross section (Max N° x mm <sup>2</sup> )		Pieces for package	A x B x C (mm)
	Combination			
Happy Joint 3	3 x 1 - 4	2 through / 1 branch	4 pcs/ Blister	41 x 28 x 19
Happy Joint 36	3 x 1 - 6	2 through / 1 branch	2 pcs/ Blister	45 x 37 x 24



## Happy Joint 4

Product	Formation and wires cross section (Max N° x mm <sup>2</sup> )		Pieces for package	A x B x C (mm)
	Combination			
Happy Joint 4	4 x 1 - 4	2 through / in/out	2 pcs/ Blister	45 x 37 x 24
Happy Joint 46	2+2 x 1 - 6	2 through / in/out	2 pcs/ Blister	45 x 37 x 24



## Happy Joint 5

Product	Formation and wires cross section (Max N° x mm <sup>2</sup> )		Pieces for package	A x B x C (mm)
	Combination			
Happy Joint 5	5 x 1 - 4	2 through / 3 branch	2 pcs/ Blister	45 x 37 x 24
Happy Joint 56	5 x 1 - 6	2 through / 3 branch	1 pc/ Blister	53 x 39 x 24



## Happy Joint 6

Product	Formation and wires cross section (Max N° x mm <sup>2</sup> )		Pieces for package	A x B x C (mm)
	Combination			
Happy Joint 6	6 x 1 - 4	3 through / in/out	1 pc/ Blister	53 x 39 x 24







# Gel Box Line

Pre-filled gel accessories for sealing, protecting and making safe electrical connections.

- To put household systems in order
- For civil and industrial connections
- Also for submersible use
- Non-toxic and with no shelf life
- Versatile and ready to use
- Designed with dimensions suitable for the most commonly used connectors
- Halogen free
- UV resistant



**Electrical performance:**  
CEI EN 50393 as applicable  
(testing under water head  
of the accessory installed in a box)

**Gel:** UL 94-HB 

Operating temperature  90°

Installation temperature:  -40°C / +50°C

Fully submersible 

Can be used underground 

**IPX8**  
OFFICIALLY TESTED 

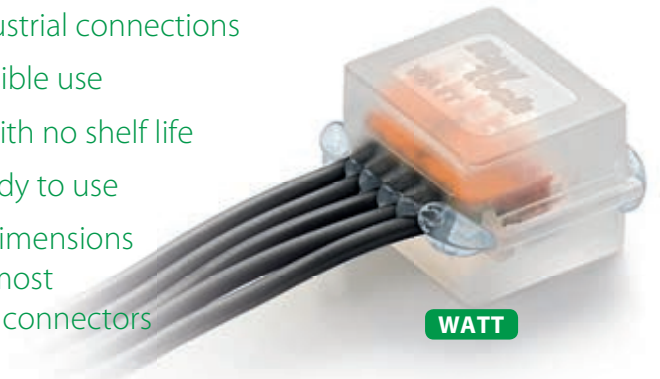

WATT



**GEL BOX LINE**  
*a simple way  
to bring indoor  
connectors  
outdoors*



JOULE

ISAAC

KELVIN

PASCAL

Gel



## Isaac



Product	Description	Package	A x B x C (mm)
Isaac 4	x 4 pcs	Blister	30 x 27 x 23
Isaac 4 P30	x 30 pcs	Box	
Isaac 4 MP *	x 50 pcs	Multipack	

IDEAL FOR (or similar):



## Pascal



Product	Description	Package	A x B x C (mm)
Pascal 6	x 2 pcs	Blister	36 x 37 x 26
Pascal 6 P15	x 15 pcs	Box	
Pascal 6 MP *	x 25 pcs	Multipack	

IDEAL FOR (or similar):



\* Also available the flame retardant version in the following colours: yellow, orange, blue or black.



# JOINTS

## GEL CONNECTION

Micro-joints IPX8

### LV



## Watt



Product	Description	Package	A x B x C (mm)
Watt	x 2 pcs	Blister	
Watt P15	x 15 pcs	Box	30 x 42 x 26
Watt MP *	x 25 pcs	Multipack	

IDEAL FOR (or similar):



## Joule



Product	Description	Package	A x B x C (mm)
Joule	x 1 pcs	Blister	
Joule MP *	x 20 pcs	Multipack	33 x 52 x 26

IDEAL FOR (or similar):



## Kelvin



Product	Description	Package	A x B x C (mm)
Kelvin	x 1 pcs	Blister	
Kelvin P9	x 9 pcs	Box	52 x 53 x 29
Kelvin MP *	x 20 pcs	Multipack	

IDEAL FOR (or similar):



Also available the flame retardant version in the following colours: yellow, orange, blue or black.





# Gel Box Line Kit

Complete with connectors.

## Pascal M2,5



Product	Description	Package	A x B x C (mm)
Pascal M2,5	12 pieces + 36 terminal blocks (2.5 mm <sup>2</sup> )	Box	36 x 37 x 26



## Kelvin M4

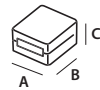

Product	Description	Package	A x B x C (mm)
Kelvin M4	6 pieces + 24 terminal blocks (4 mm <sup>2</sup> )	Box	52 x 53 x 29

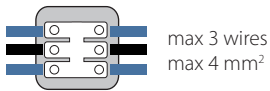

## Watt +



Product	Description	Package	A x B x C (mm)
Watt + 1.5	10 pieces + 30 end connectors/terminal blocks (1.5 mm <sup>2</sup> )	Box	30 x 42 x 26
Watt + 2.5	10 pieces + 30 end connectors/terminal blocks (2.5 mm <sup>2</sup> )	Box	



## Kelvin +

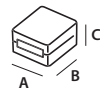

Product	Description	Package	A x B x C (mm)
Kelvin + 4	10 pieces + 30 end connectors/terminal blocks (4 mm <sup>2</sup> )	Box	52 x 53 x 29
Kelvin + 6	10 pieces + 30 end connectors/terminal blocks (6 mm <sup>2</sup> )	Box	
Kelvin 6+4	6 pieces + 20 end connectors/terminal blocks (4 mm <sup>2</sup> )	Box	
Kelvin 6+6	6 pieces + 20 end connectors/terminal blocks (6 mm <sup>2</sup> )	Box	





# JOINTS

## GEL CONNECTION

Micro-joints IPX8

# LV

# Gel Cover Line

Pre-filled gel accessories for straight connections, for the protection, safety and covering of electrical connections using strip connectors or alternatives.

- For 3 x 1 to 6 mm<sup>2</sup> cables or 3 insulated wires
- For civil and industrial connections
- To put household systems in order
- Also for underwater use
- Non-toxic and with no shelf life
- Halogen free
- UV resistant

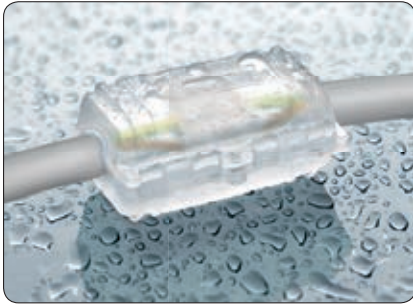

**Electrical performance:**  
CEI EN 50393 with connectors complying with EN 61238-1 (with testing under water head and water between the cable cores)  
Class 2 in accordance with CEI 64-8.

Gel: UL 94-HB

Operating temperature

Installation temperature: -40°C / +50°C

**IPX8**  
OFFICIALLY TESTED | **IMQ**

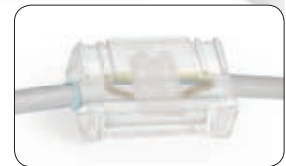
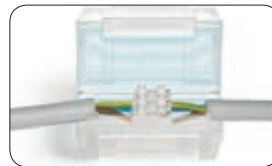
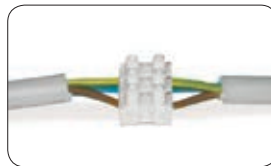
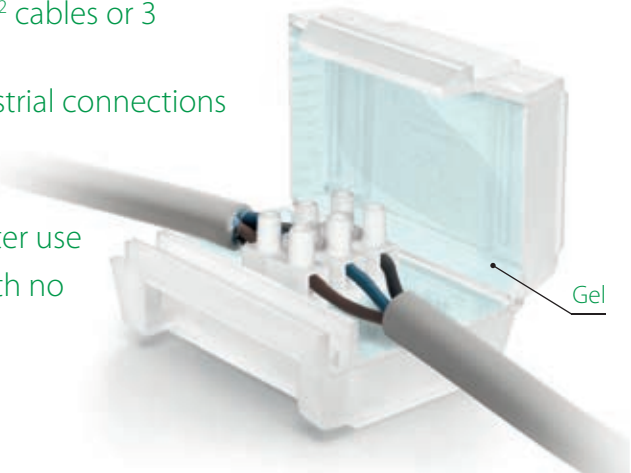

# OHM & BAR

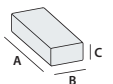

Product	Housed connectors type	Pieces for package	Package type	Dimensions A x B x C (mm)
OHM	2 from 4 mm <sup>2</sup>	1	Blister	61 x 35 x 28
OHMp11		11	Box	
BAR	3 from 4 mm <sup>2</sup> / 6 mm <sup>2</sup>	1	Blister	63 x 41 x 28
BARp9		9	Box	



# Mammut Gel Cover

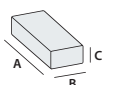

Product	Housed connectors type	Pieces for package	Package type	Dimensions A x B x C (mm)
Gel Cover 4	2 from 4 mm <sup>2</sup>	1	Blister	61 x 35 x 28
Mammut Gel Cover		8	Box	
Gel Cover 6	3 from 4 mm <sup>2</sup> / 6 mm <sup>2</sup>	1	Blister	63 x 41 x 28
Mammut Gel Cover 6		6	Box	

No flame propagation. CEI 20-35 • IEC 60332-1 • HD405-1 (as applicable). **Casing mix:** UL 94-V2

Installation examples

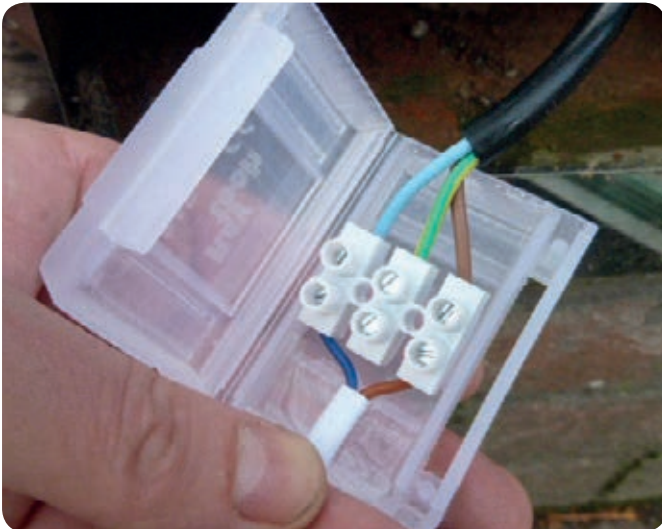



# Nano Joint

Pre-filled gel accessories to seal, protect and make safe electrical connections.  
Inclusive of connectors

**Electrical performance:**  
CEI EN 50393 as applicable  
(testing under water head  
of the accessory installed in a box)

Gel: UL 94-HB 

Operating temperature 

Installation temperature:   
-40°C / +50°C

Fully submersible 

Can be used underground 

**IPX8**  
OFFICIALLY  
TESTED | **IMQ**

- Ready to use, quick, re-enterable!
- No tools required
- Can energise immediately
- For straight & branch connections
- For rigid or flexible insulated wires from 1 a 4 mm<sup>2</sup>
- For 1, 2 and 3 cores connections
- Up to 5 conductors on one phase or up to 2 conductors on two or three phase
- Small, compact and resistant
- No shelf life
- Halogen free
- UV resistant



**NANO JOINT 3**

**NANO JOINT 5**

**NANO JOINT 6**

*Latest generation,  
extra flat  
connectors  
included in the kit.*



## Nano 3

Product	Formation and wires cross section (Max N° x mm <sup>2</sup> )	Combination	Pieces for package	A x B x C (mm)
Nano 3	3 x 1 - 4	2 through / 1 branch	4 pcs Blister	30 x 27 x 23



With one connector included for each Nano Joint



## Nano 5

Product	Formation and wires cross section (Max N° x mm <sup>2</sup> )	Combination	Pieces for package	A x B x C (mm)
Nano 5	5 x 1 - 4	2 through / 3 branch	2 pcs Blister	30 x 42 x 26



With one connector included for each Nano Joint



## Nano 6

Product	Formation and wires cross section (Max N° x mm <sup>2</sup> )	Combination	Pieces for package	A x B x C (mm)
Nano 6	6 x 1 - 4	3 through / In/Out	1 pcs Blister	33 x 52 x 26



With three connectors included for each Nano Joint







# JOINTS

## GEL CONNECTION

Micro-joints IPX8

# LV



# Nano Mam - For

**Electrical performance:**  
CEI EN 50393 as applicable  
(testing under water head  
of the accessory installed in a box)

Gel: UL 94-HB 

Operating temperature 

Installation temperature:   
-40°C / +50°C

Fully submersible   
Can be used underground 

**IPX8**  
OFFICIALLY  
TESTED | **IMQ**

Pre-filled gel accessories to seal, protect and make safe electrical connections. Inclusive of connectors.

- Ready to use, quick, re-enterable!
- Ideal for outdoor & underground installations, fully submersible
- Immediately energizable
- For rigid or flexible insulated wires from 1 a 4 mm<sup>2</sup>
- For 1, 2 or 3 cores connections
- Small, compact and resistant
- No shelf life
- Halogen free
- UV resistant



**NANO FOR 2,5**

**NANO FOR 4**

**NANO MAM 4**

**NANO MAM 2,5**

*Kit with end  
connectors/  
terminal blocks*

*Kit with  
terminal blocks*



## Nano Mam 2,5

Product	Formation and wires cross section (Max N° x mm <sup>2</sup> )	Combination	Pieces for package	A x B x C (mm)
Nano Mam 2,5	3 x 1 - 2,5	3 through	2 pcs/ Blister	36 x 37 x 26



With one connector included for each Nano Mam

## Nano Mam 4

Product	Formation and wires cross section (Max N° x mm <sup>2</sup> )	Combination	Pieces for package	A x B x C (mm)
Nano Mam 4	3 x 1,5 - 4	3 through	1 pcs/ Blister	52 x 53 x 29

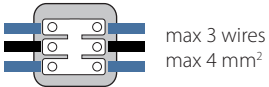

With one connector included for each Nano Mam

## Nano For 2,5

Product	Formation and wires cross section (Max N° x mm <sup>2</sup> )	Combination	Pieces for package	A x B x C (mm)
Nano For 2,5	3 x 1 - 2,5	3 connections / In/Out	1 pcs/ Blister	33 x 52 x 26



With one connector included for each Nano For

## Nano For 4

Product	Formation and wires cross section (Max N° x mm <sup>2</sup> )	Combination	Pieces for package	A x B x C (mm)
Nano For 4	3 x 1 - 4	3 connections / In/Out	1 pcs/ Blister	52 x 53 x 29



With one connector included for each Nano For





## JOINTS

### GEL CONNECTION

Micro-joints IPX8

## LV

# Bravo

The first "Gel-Box" with integrated connectors!

**Electrical performance:**  
CEI EN 50393 as applicable  
(testing under water head  
of the accessory installed in a box)

**Gel:** UL 94-HB 

**Operating voltage:** 0,6 / 1kV

**Operating temperature** 

**Installation temperature:**   
-40°C / +50°C

**Fully submersible** 

**Can be used underground** 

**IPX8**  
OFFICIALLY  
TESTED | **IMQ**

- Ready to use, quick, re-enterable!
- For rigid or flexible insulated wires from 1 a 6 mm<sup>2</sup>
- Immediately energizable
- For straight & branch connections
- For 1 or 3 cores connections
- Small, compact and transparent
- No shelf life
- Halogen free and UV resistant

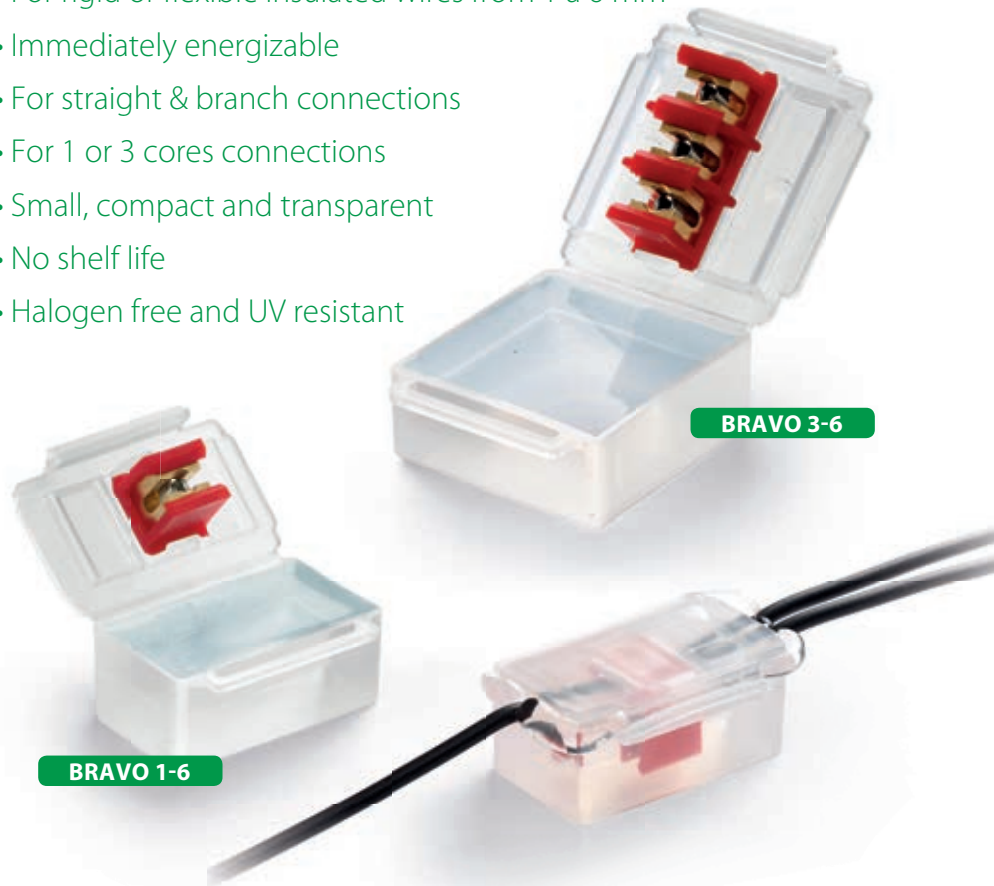

# Mini Bravo

Extra-flat mini box  
with terminal block.

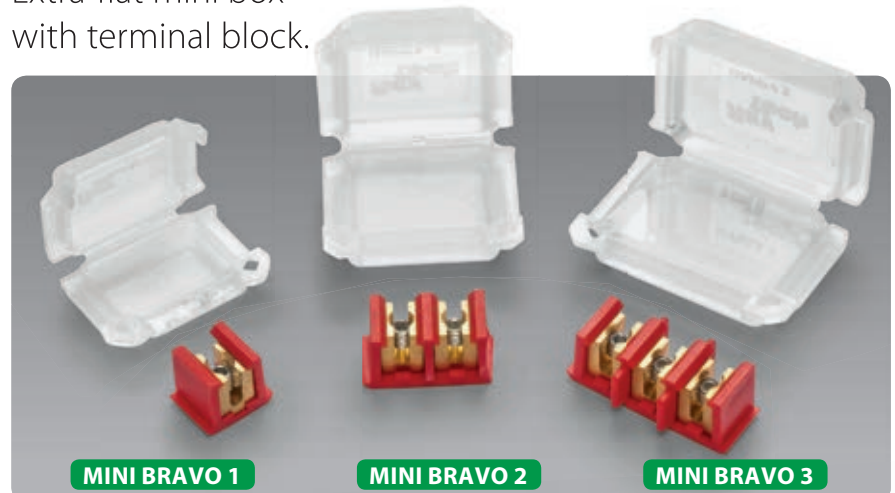
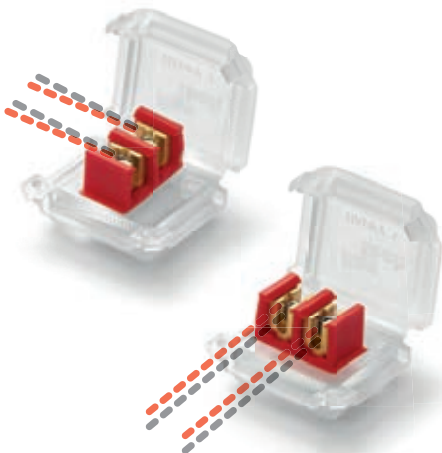



Bravo - Self-locking connection block.

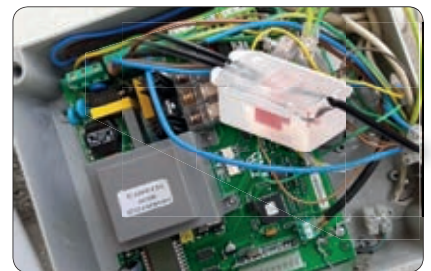
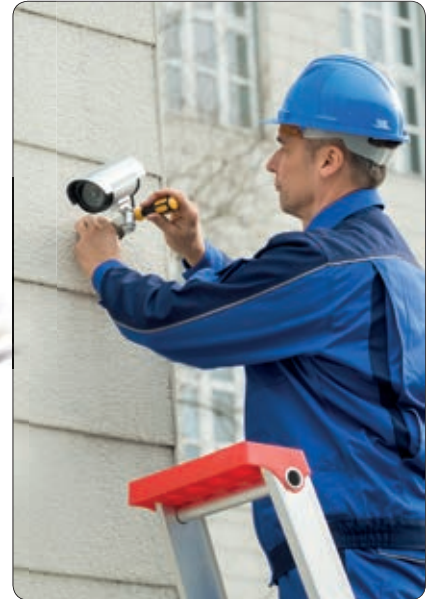
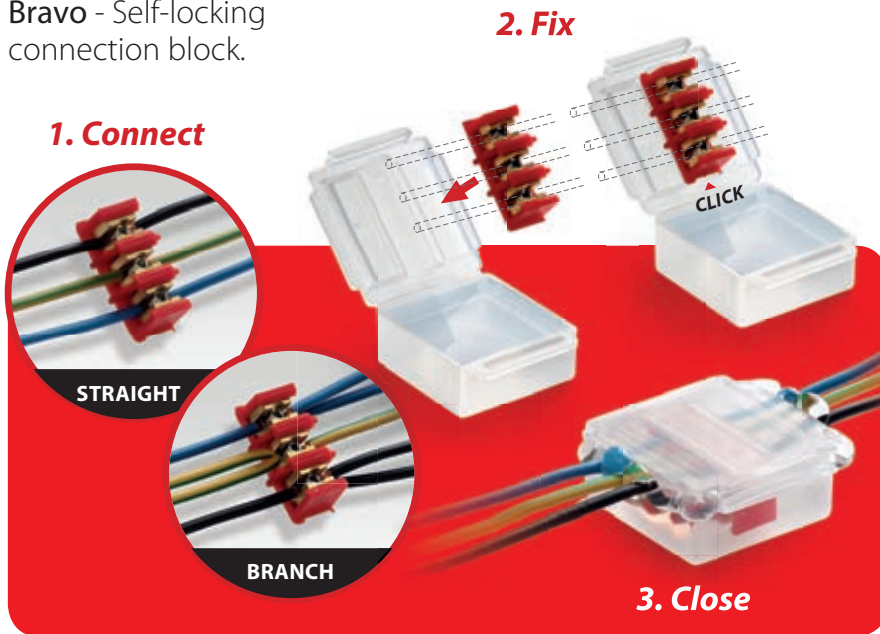

Bravo

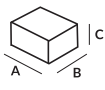
Product	Formation and wires cross section		Pieces for package	 A x B x C (mm)
	Straight or through (N° x mm <sup>2</sup> )	Branch (N° x mm <sup>2</sup> )		
Bravo 1-6	1 x 1 - 6	1 x 1 - 6	1 pcs/ Blister	50 x 29 x 22
Bravo 3-6	2 x 1 - 6 3 x 1 - 6	2 x 1 - 6 3 x 1 - 6	1 pcs/ Blister	53 x 49 x 22

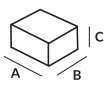

Mini Bravo

Product	Formation and wires cross section		Pieces for package	 A x B x C (mm)
	Straight or through (N° x mm <sup>2</sup> )	Branch (N° x mm <sup>2</sup> )		
Mini Bravo 1	1 x 1 - 4	1 x 1 - 4	3 pcs/ Blister	41 x 28 x 19
Mini Bravo 2	2 x 1 - 4	2 x 1 - 4	1 pcs/ Blister	45 x 37 x 24
Mini Bravo 3	3 x 1 - 4	3 x 1 - 4	1 pcs/ Blister	53 x 39 x 24





# JOINTS

## GEL CONNECTION

Micro-joints IP68/IP69K



Electrical performance:  
CEI EN 50393  
as applicable

Gel: UL 94-HB

Operating temperature

Installation temperature:   
-40°C / +50°C

Fully submersible

Can be used underground

**IP69K** OFFICIALLY TESTED **IP68** OFFICIALLY TESTED **IMQ**



**IP68:** (6) protected against dust and solid objects over 1 mm.  
(8) Protected from permanent immersion in water.  
**IP69K:** (9K) protected against close-range high pressure, high temperature spray downs.

# LV

# Little Joint Line



The IP68 / IP69K micro-joints, gel pre-filled, complete with connector, suitable for any type of installation, even the most extreme.

Extremely compact and space-saving, pre-filled with soft, highly conformable gel. With minimal aesthetic impact and visually pleasing. Equipped with integrated cable glands for IP68 and IP69K degree of ingress protection and cable retention.

- Pre-filled with classified non-toxic gel
- Extremely compact and ready to install
- Ideal for connections in lighting systems for gardens, steps and stairways, pedestrian crossings, etc.
- Halogen Free & UV resistant
- Always re-enterable

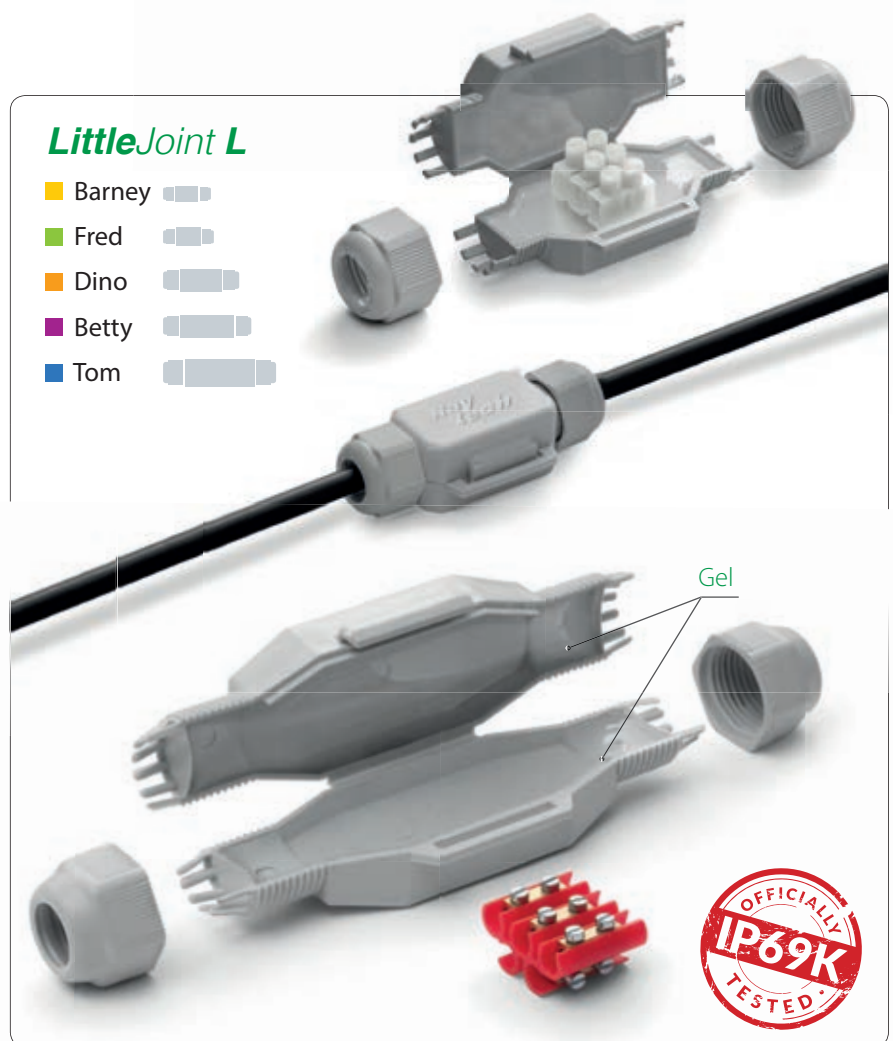

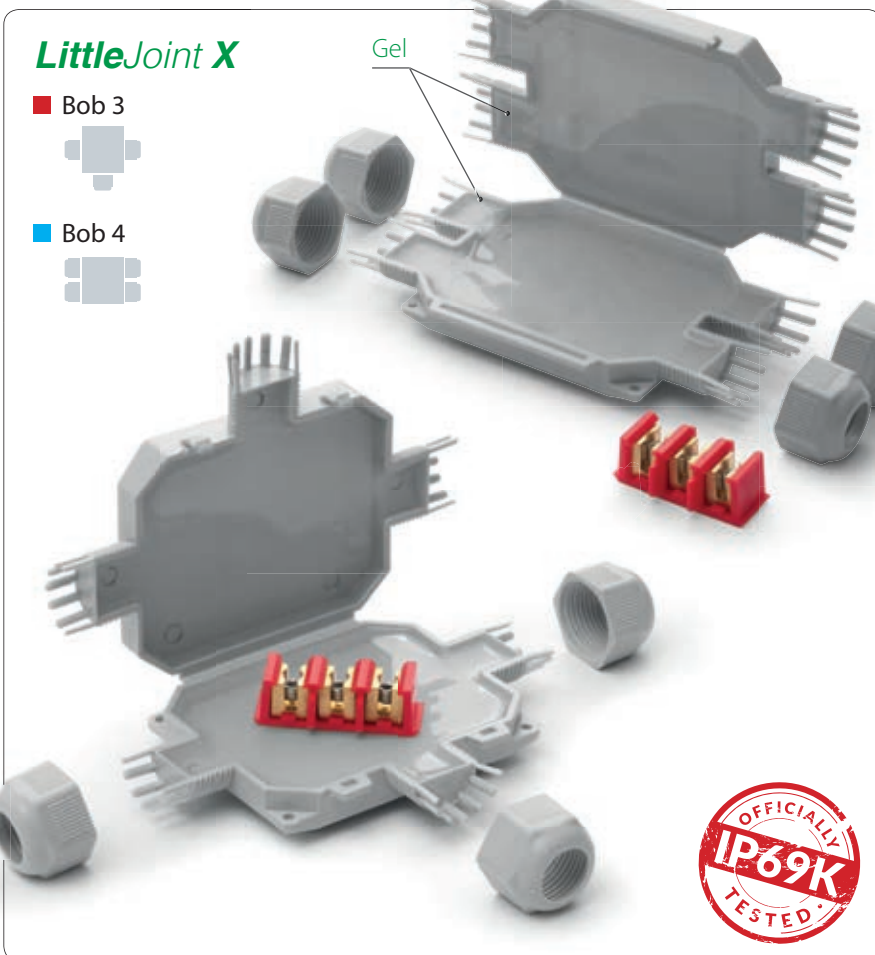
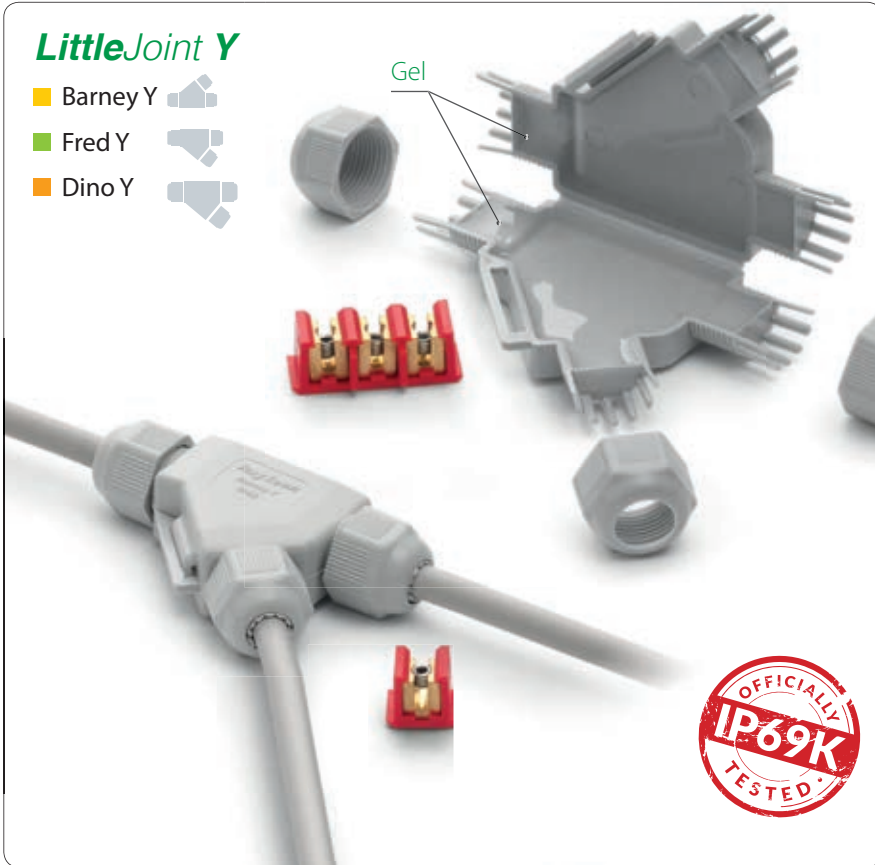



### LittleJoint L

Product	Colour	Connector	Cable formation max (N° x mm <sup>2</sup> )		Ø cables min - max (mm)	Pieces / Pack	A x B x C (mm)
			Through	Branch			
Barney	●		2 x 2,5	6 - 10	1 / Blister	75 x 28 x 19	
Barney - N	●				1 / Blister		
Barney MP	●				10 / Multipack		
Fred	●		3 x 2,5	8 - 13	1 / Blister	80 x 36 x 23	
Fred - N	●				1 / Blister		
Fred MP	●				10 / Multipack		
Fred/4	●		3 x 4	8 - 13	1 / Blister	80 x 36 x 23	
Fred/4 - N	●				1 / Blister		
Dino	●		4 x 4	10 - 16	1 / Blister	125 x 43 x 35	
Dino - N	●				1 / Blister		
Betty/4	●		5 x 4	10 - 16	1 / Blister	145 x 46 x 35	
Betty/4 - N	●				1 / Blister		
Betty/6	●		5 x 6	14 - 19	1 / Blister	145 x 46 x 35	
Betty/6 - N	●				1 / Blister		
Tom	●		5 x 16	19 - 23	1 / Blister	180 x 53 x 42	
Tom-N	●				1 / Blister		

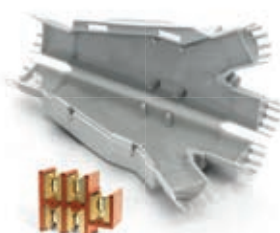
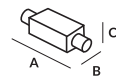

### LittleJoint Y

Product	Colour	Connector	Cable formation max (N° x mm <sup>2</sup> )		Ø cables min - max (mm)	Pieces / Pack	A x B x C (mm)
			Through	Branch			
Barney Y	●		1 x 4 1 x 2,5	1 x 1,5 1 x 2,5	6 - 10	1 / Blister	85 x 55 x 22
Barney Y - N	●				1 / Blister		
Fred Y	●		3 x 4 3 x 2,5	3 x 1,5 3 x 2,5	8 - 13	1 / Blister	110 x 72 x 25
Fred Y - N	●				1 / Blister		
Dino Y	●		5 x 6 5 x 4 *	5 x 1,5 5 x 2,5 *	14 - 19	1 / Blister	160 x 75 x 37
Dino Y - N	●				1 / Blister		

\* section for rigid cables

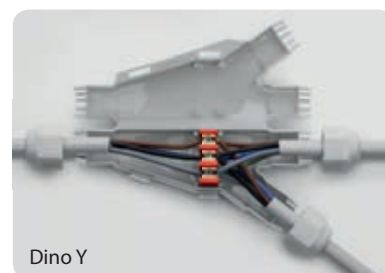
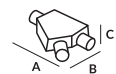



LittleJoint X

Product	Colour	Connector	Cable formation max (N° x mm <sup>2</sup> )		Ø cables min - max (mm)	Pieces / Pack	A x B x C (mm)
			Through	Branch			
Bob 3	●		1 cable 3 x 4	2 cables 3 x 4	8 - 13	1 / Blister	105 x 80 x 25
Bob 3 - N	●		3 x 2,5	2 cables 3 x 2,5			
Bob 4	●		1 cable 3 x 4	2 cables 3 x 4	8 - 13	1 / Blister	105 x 65 x 25
Bob 4 - N	●		3 x 2,5	3 cables 3 x 2,5			

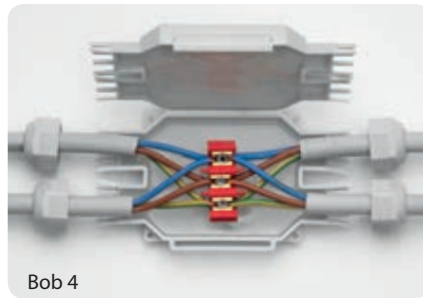
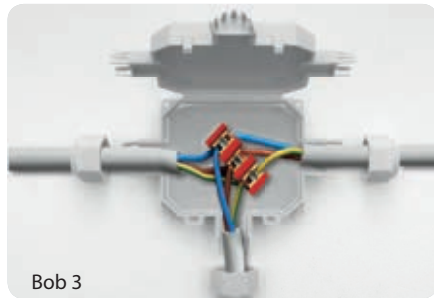
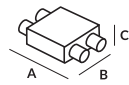

Some installation possibilities for Bob 4

Parallel branch system with 3 three-core cables up to 3 x 4 mm<sup>2</sup>

Parallel branch system with 4 three-core cables up to 3 x 2.5 mm<sup>2</sup>

Parallel 5-lamp connection system

**Can be installed with Mammut type connector (not included)**

3-LED spotlight in-series system

3-LED RGB spotlight parallel system with four-core cables



For use in traps. The ideal accessory for branch connections from a through cable to light fittings and spotlights. Suitable in applications where there is presence of water and moisture.







### Electrical performance:

CEI EN 50393  
as applicable

Gel: UL 94-HB 

**Halogen free:**  
according to CEI EN 50267 2-2

**Self-extinguishing and  
resistant to abnormal  
heat and fire:**

Glow wire test a +960°C  
according to EN 60695-2-11

Operating temperature 

Gel operating temperature:  
-60°C / +200°C 

**IP69K**  
OFFICIALLY  
TESTED

**IP68**  
OFFICIALLY  
TESTED

**IMQ**

# Fox Box IP68

3 or 5 entrance jointing enclosure with gel filled perimeter chamber providing lighter weight with maximum capacity.

Kit includes accessories to maximise versatility allowing the use of cables from 6 to 18 mm in diameter or with 16, 20 and 32 mm diameter cable conduits. The internal, gel-free compartment allows for dry connections or any future alterations or disconnections. The gel, contained in the perimeter chamber also surrounds, insulates and seals any armour continuity connections or cable shields.

- Functional, elegant design
- Ideal for exposed and safety systems and for video camera installation
- Ready for use
- Click and hook closure, does not require screws
- Ready and installable in all environmental conditions
- Also suitable for wet or flooded environments
- No shelf life
- Always re-enterable
- Wall or external ceiling fixing system
- Halogen free & UV resistant



# FOX BOX

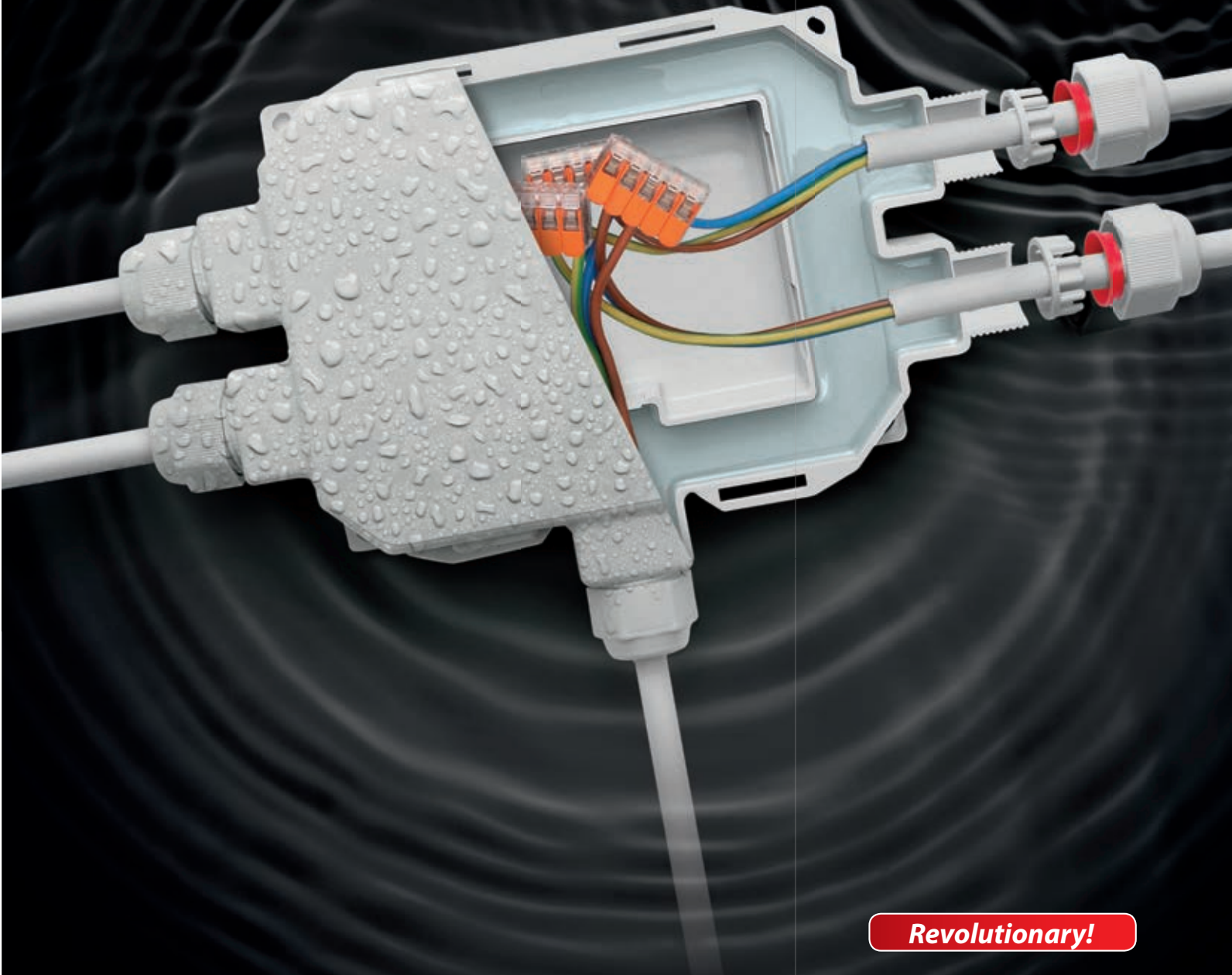

**Revolutionary!**

Safe, fast, elegant, lightweight and versatile!

**IP68**  
OFFICIALLY  
TESTED



CABLES

Ø 6-13



Ø 13-18



TUBES

Ø 16



Ø 20

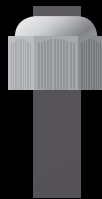

Ø 32



Ray Ray  
Technik



# JOINTS

# LV

## GEL CONNECTION

Box IP68/IP69K

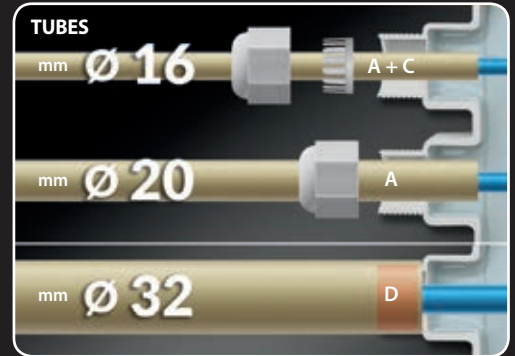
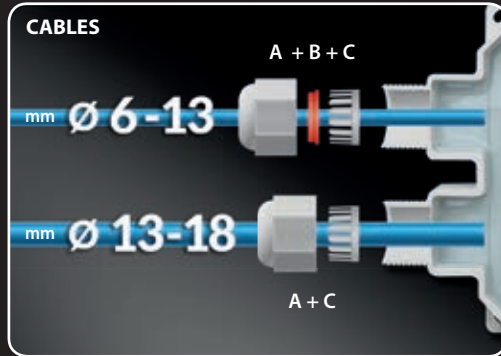
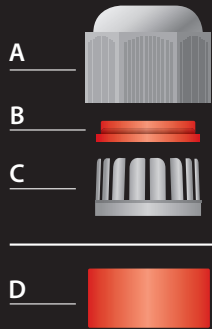

### FOX BOX

Box with 5 entrances for cables and conduits

Screwless click hook closure

Cable sheath, armour and shield storage compartment

Gel-free connection storage compartment

Chamber pre-filled with insulating and sealing gel

Can be mounted on walls or ceilings



Ray Tech

Product	Colour	N° of entrances	Ø entrances with cable glands		Ø tubes (mm)	A x B x C (mm)
			min (mm)	max (mm)		
FOX BOX	●					
FOX BOX - N	●	5	6	18	16/20/32	210 x 155 x 45
FOX BOX - ARM	●					

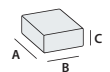



**FOX BOX 3**

Box with 3 entrances for cables and conduits

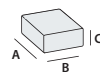
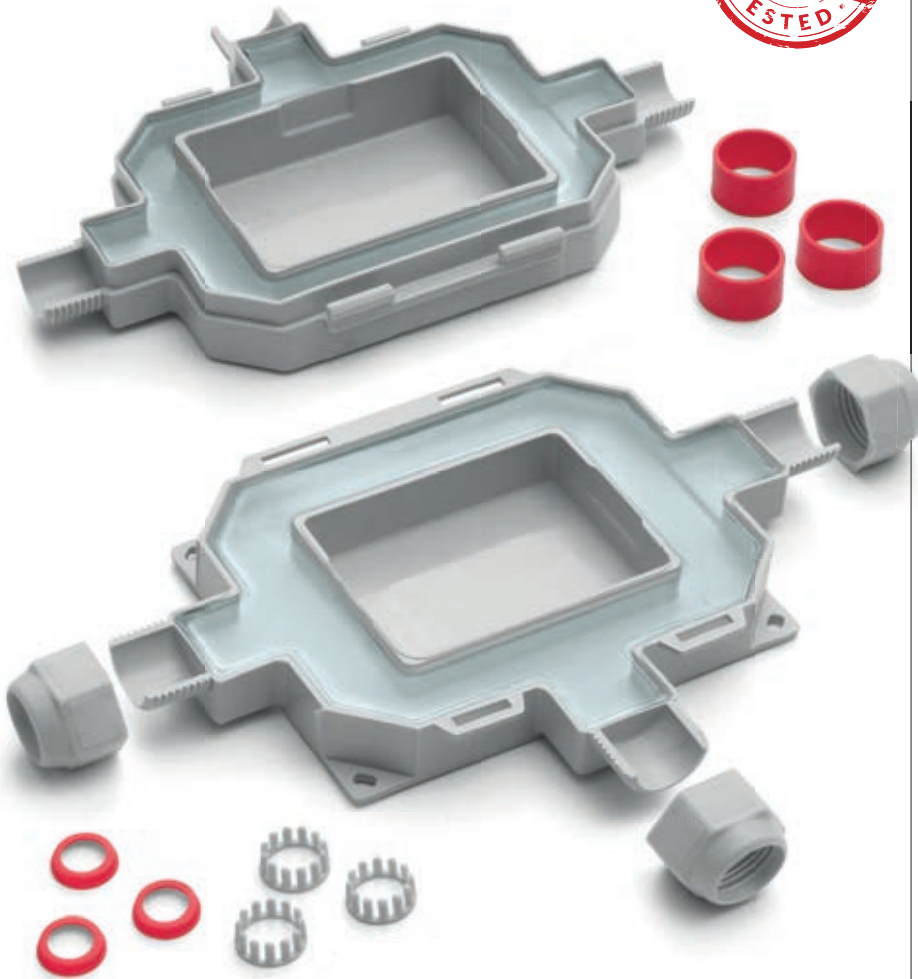

Product	Colour	N° of entrances	Ø entrances with cable glands		Ø tubes (mm)	A x B x C (mm)
			min (mm)	max (mm)		
FOX BOX 3	●					
FOX BOX 3 - N	●	3	6	18	16 / 20 / 32	180 x 135 x 45
FOX BOX 3 - ARM	●					



**Ray  
tech**



## JOINTS

### GEL CONNECTION

Box IP68/IP69K

## LV

#### Revolutionary!

##### Electrical performance:

CEI EN 50393 as applicable  
Class 2 in accordance with CEI 64-8.

Gel: UL 94-HB 

##### Halogen free:

according to CEI EN 50267 2-2

##### Self-extinguishing and resistant to abnormal

##### heat and fire:

Glow wire test a +960°C  
according to EN 60695-2-11

Operating temperature 

Gel operating temperature:   
-60°C / +200°C

**IP69K**  
OFFICIALLY  
TESTED

**IP68**  
OFFICIALLY  
TESTED

**IMQ**

# Ready & Baby Box

3 or 4 entrances junction boxes pre-filled with gel, complete with integrated terminal block and cable glands for 8 to 18 mm diameter cables and for 16/20/32 mm ducts/conduit.

- Ready to use, they can be installed in all environmental conditions
- Also suitable for wet or flooded environments
- Always re-enterable
- Pre-filled with gel. Non-toxic and non-classified as hazardous under CLP
- Pre-threaded entries for cable gland mounting
- Snap shut closure, does not require screws
- Wall or external ceiling fixing system
- Halogen free & UV resistant
- No shelf life

**Box pre-filled with non-toxic, safe gel. Nothing to pour, mix or cast!**



Ready, safe, quick and innovative



Ready Box IP68 - 120

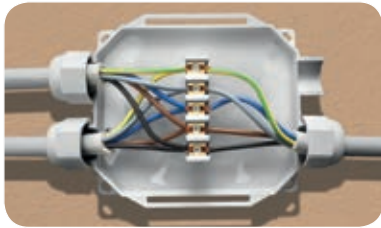

Ready Box IP68 - 90

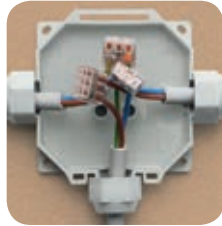
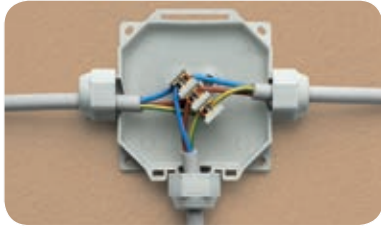

Thanks to its innovative design, unlike a standard box, there is no need to break through the walls of the box to insert the cable.

Also suitable for extra-flat lever connectors.

Also suitable for screw terminals.



Installation with free cables.



Installation with cable gland duct.

**READY BOX 120**

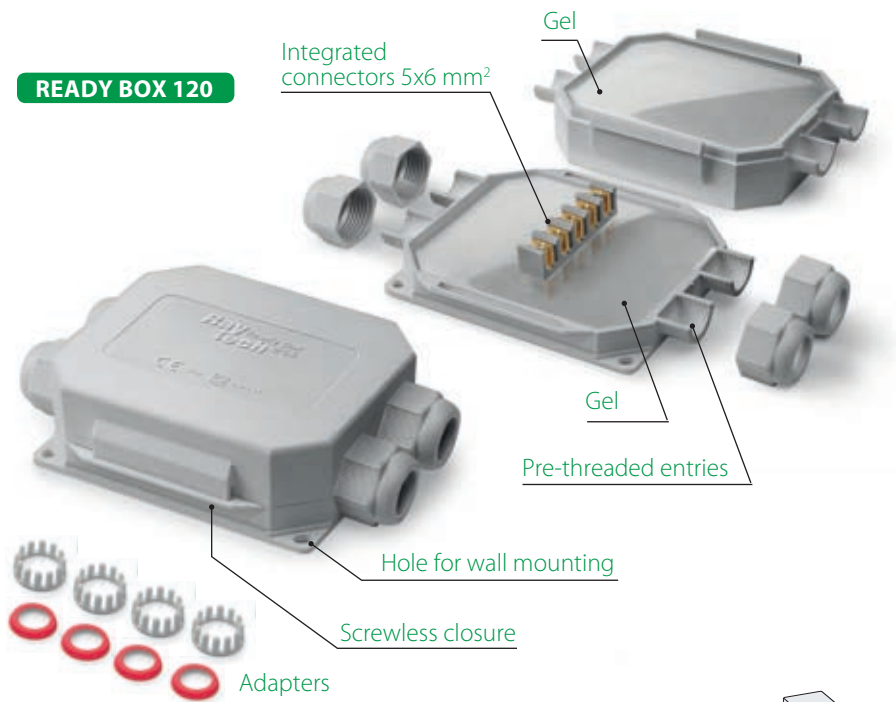

**READY BOX 90**



Product	Colour	Ø	Ø entrances with cable glands		Ø tubes (mm)	A x B x C (mm)
			min (mm)	max (mm)		
Ready Box IP68 90	●	3	8	18	16/20/32	90 x 90 x 45
Ready Box IP68 90/N	●					
Ready Box IP68 120	●	4	8	18	16/20/32	120 x 100 x 45
Ready Box IP68 120/N	●					

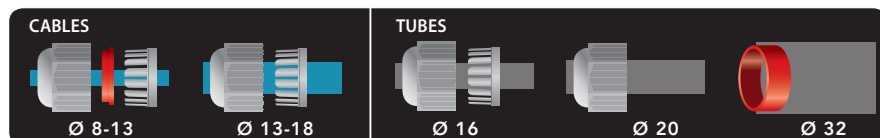

JOINT *or* BOX?

# BABY BOX

*The pre-filled gel accessory with integrated terminal block*



*Nothing to pour,  
mix or cast!*

**Ray  
Tech** **New**

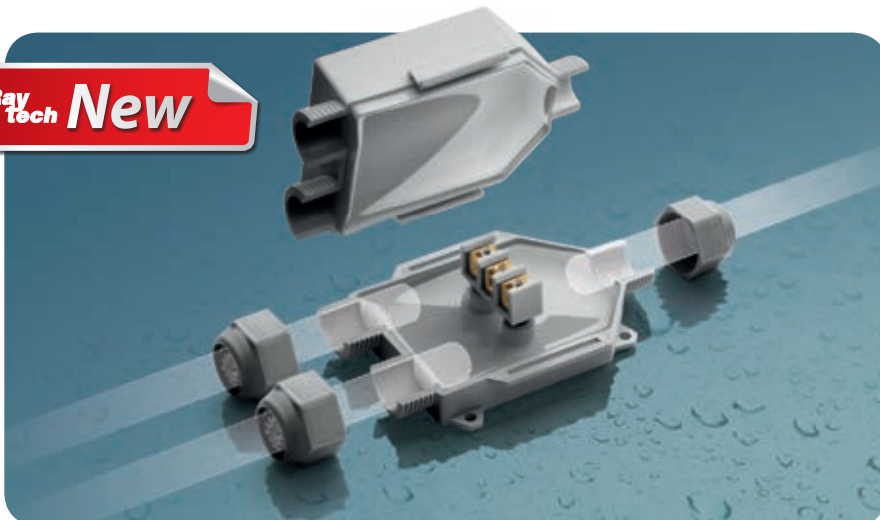

Compact, fast,  
ready, complete.





**BABY BOX**

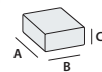
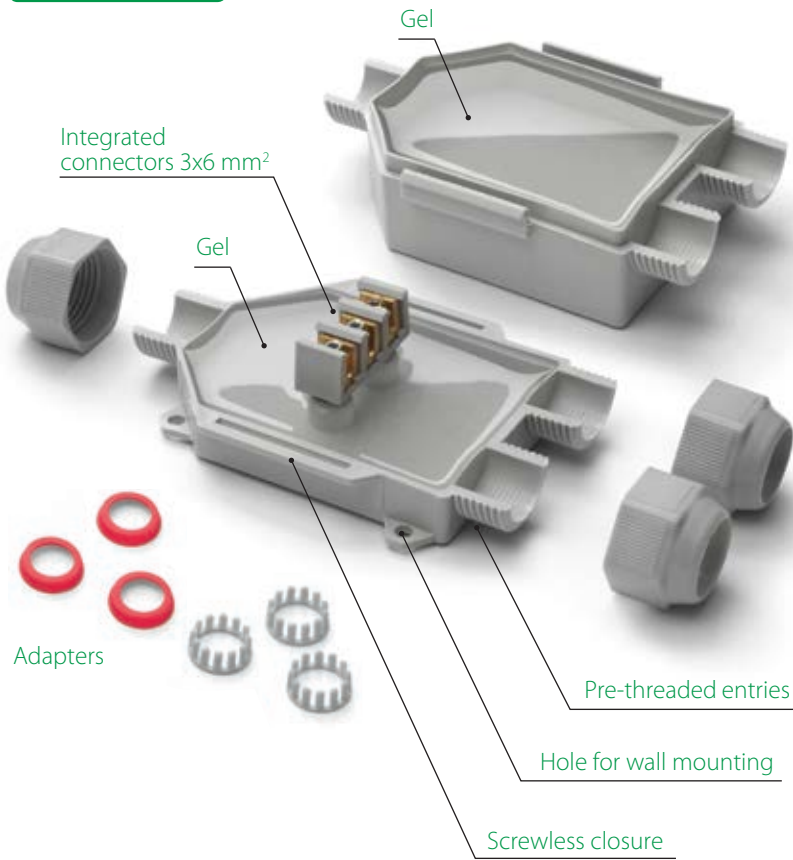

Product	Colour	Ø	Ø entrances with cable glands		Ø tubes (mm)	A x B x C (mm)
			min (mm)	max (mm)		
Baby Box IP68	●	3	8	18	16 / 20	90 x 80 x 47
Baby Box IP68/N	●	3	8	18	16 / 20	90 x 80 x 47

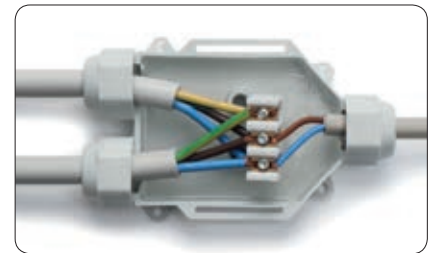
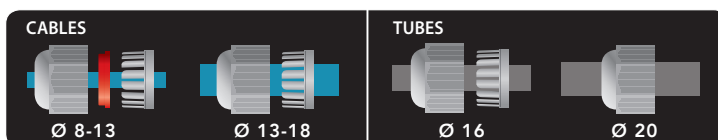

With integrated connectors.

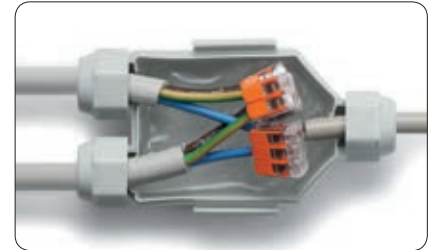

Also suitable for extra-flat lever connectors.



Also suitable for screw terminals.







PRE-FILLED WITH GEL  
for integrated connections



**Electrical performance:** CEI EN 50393  
(with testing under water head  
and water between the cable cores)  
Class 2 in accordance with CEI 64-8.

**No flame propagation:**  
CEI 20-35 • IEC 60332-1 • HD405-1  
(as applicable)  
Low smoke and toxic and corrosive  
corrosive gas emissions

**Gel:** UL 94-HB 

**Casing mix:** UL 94-V2

**Degree of protection:** IP68

Operating temperature 

Installation temperature:   
-40°C / +50°C

**IP69K**  
OFFICIALLY  
TESTED

**IP68**  
OFFICIALLY  
TESTED

**IMQ**

# Rapid Joint IP68

Radial closing gel pre-filled joint for extruded insulation cables up to 1 kV.

Primary insulation, consisting of a cross-linked polymer gel, and the exceptionally robust insulating plastic casing render Class 2 joints in accordance with the definitions contained in standard CEI 64-8. The joint has been tested in accordance with the main international specifications, with repeated flexing and torsion tests and immersion in water, and has been declared as conforming to the mechanical, electrical and sealing specifications required for plastic cable accessories. The joint and its components have an unlimited shelf life, are chemically inert and therefore completely safe. Conductor connections are re-enterable even after long periods of operation. Made with self-extinguishing material, flame retardant, for cables at 90°C working temperature. The radial closing system facilitates joint application, making them re-enterable only by means of a tool.

- For straight connections (in line)
- For multi core cables of up to 5 cores
- With suitable spacers
- For all types of application, including submersible
- Wide range of cable formations
- Re-enterable only by means of a tool
- Suitable for 3 core crossing
- Non-toxic, with no expiry date

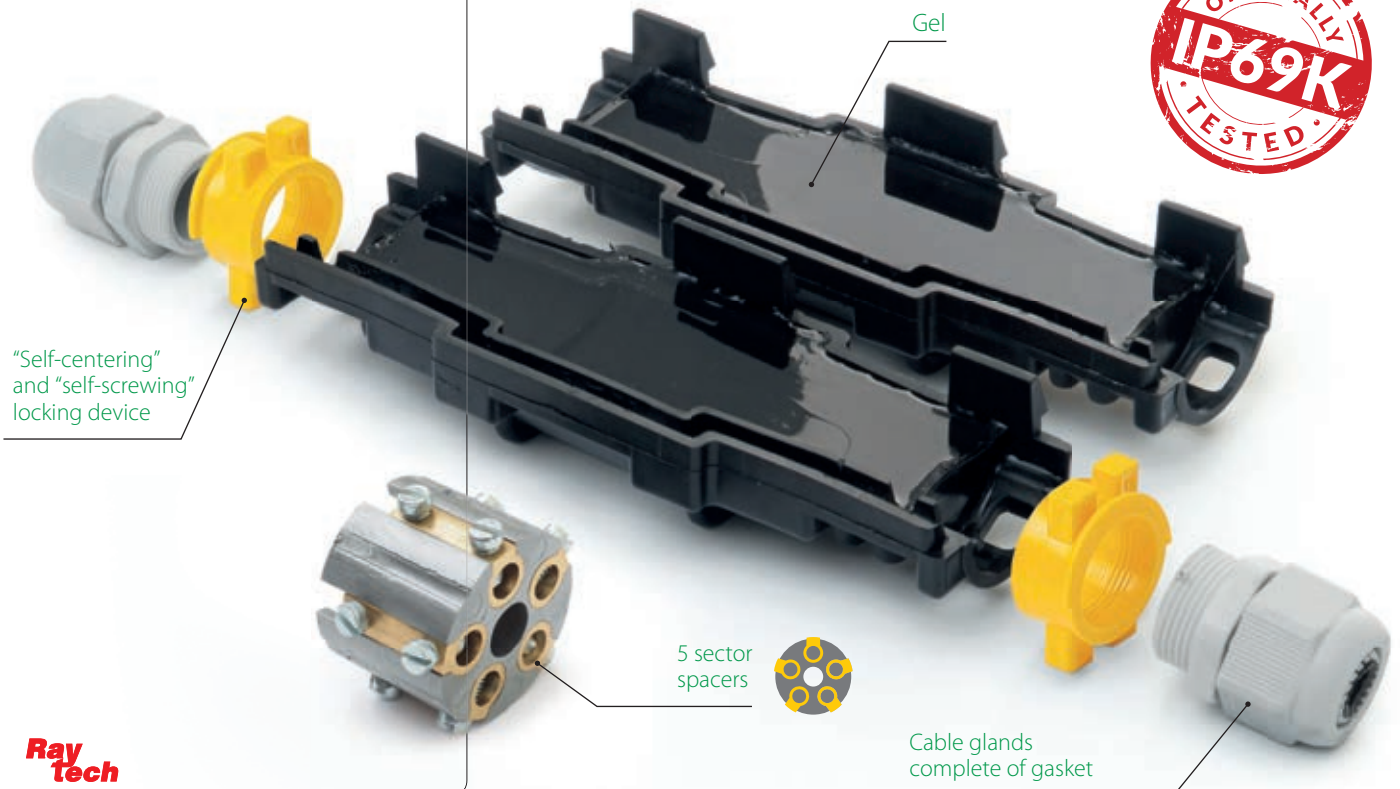



Product	Formation n°	Configuration IP68			Configuration IPX8		
		Section (mm <sup>2</sup> )	Ø cable (mm)	A x B (mm)	Section (mm <sup>2</sup> )	Ø cable (mm)	A x B (mm)
Rapid Joint L1,5-IP68	•	4 - 25			1,5 - 50		
	⊙	1,5 - 4			1,5 - 6		
	⊕	1,5 - 2,5	8 - 13	155 x 55	1,5 - 6	20,5	105 x 55
	⊗	1,5			1,5 - 6		
	⊘	1,5			1,5 - 6		
Rapid Joint L6-IP68	•	25 - 70			2,5 - 150		
	⊙	2,5 - 6			2,5 - 10		
	⊕	2,5 - 6	12 - 18	245 x 60	2,5 - 10	24	180 x 60
	⊗	2,5 - 6			2,5 - 10		
	⊘	2,5 - 6			2,5 - 10		
Rapid Joint L10-IP68	•	70 - 95			120 - 240		
	⊙	10			10 - 25		
	⊕	10	16 - 20	275 x 65	10 - 25	31	210 x 65
	⊗	10			10 - 25		
	⊘	10			10 - 25		
Rapid Joint L25-IP68	•	120 - 240			120 - 240		
	⊙	25			10 - 50		
	⊕	16 - 25	21 - 28	410 x 100	10 - 50	42	320 x 100
	⊗	16 - 25			10 - 50		
	⊘	16 - 25			10 - 50		

For single core cable: do not install the separator with screw connectors and connect with crimp connector.

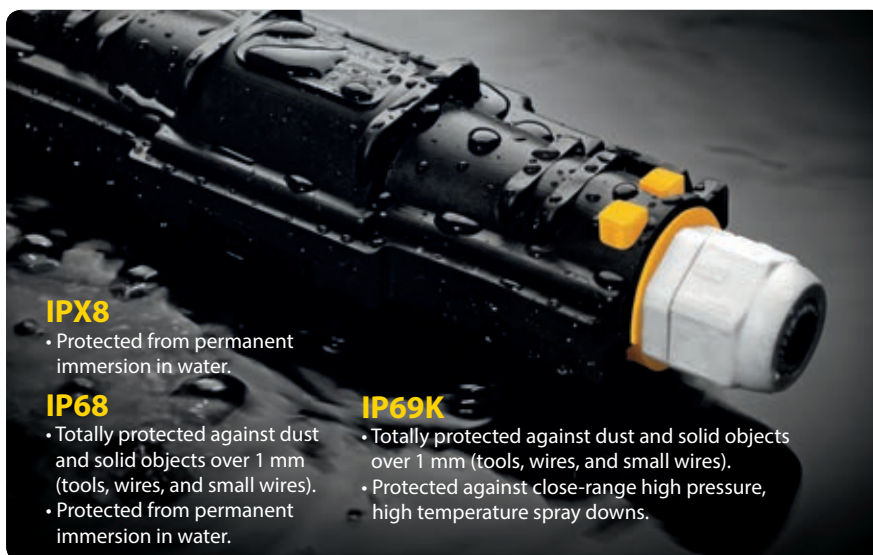
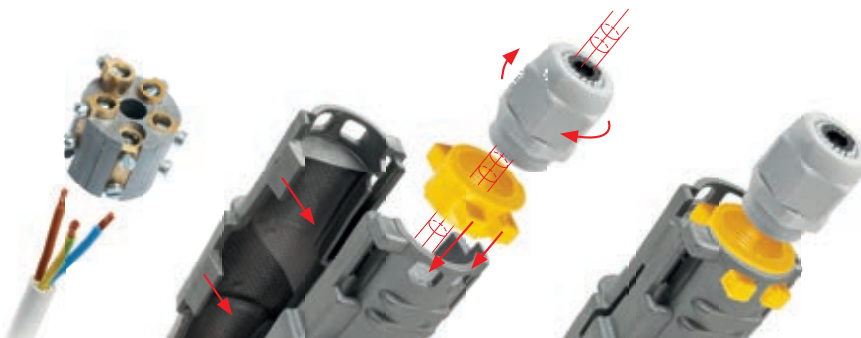





PRE-FILLED WITH GEL  
for integrated connections

## Mini Rapid Joint IP68

**Electrical performance:**  
CEI EN 50393  
as applicable

**Gel:** UL 94-HB 

Operating temperature 

Installation temperature:   
-40°C / +50°C

Fully submersible 

Can be used underground 

**IP69K** OFFICIALLY TESTED | **IP68** OFFICIALLY TESTED | **IMQ**

IP68 and IP69K joints for straight and branch connections, extremely compact and pre-filled with gel.

Extremely compact, ideal for lighting systems for gardens, steps and pedestrian crossings. Perfect for use in even small traps thanks to its very small overall dimensions. The cable glands supplied with the kit lock the joint on the cables.

- Provided with 2 (straight joints) or 3 (branch joints) cable glands to avoid accidental cable traction
- Complete with screw connectors
- Pre-filled with non-toxic, non-classified gel
- Extremely compact and ready to install
- Always re-enterable
- Halogen Free & UV resistant
- Ideal for straight or branch connections in lighting systems for gardens, steps and stairways, pedestrian crossings, etc.

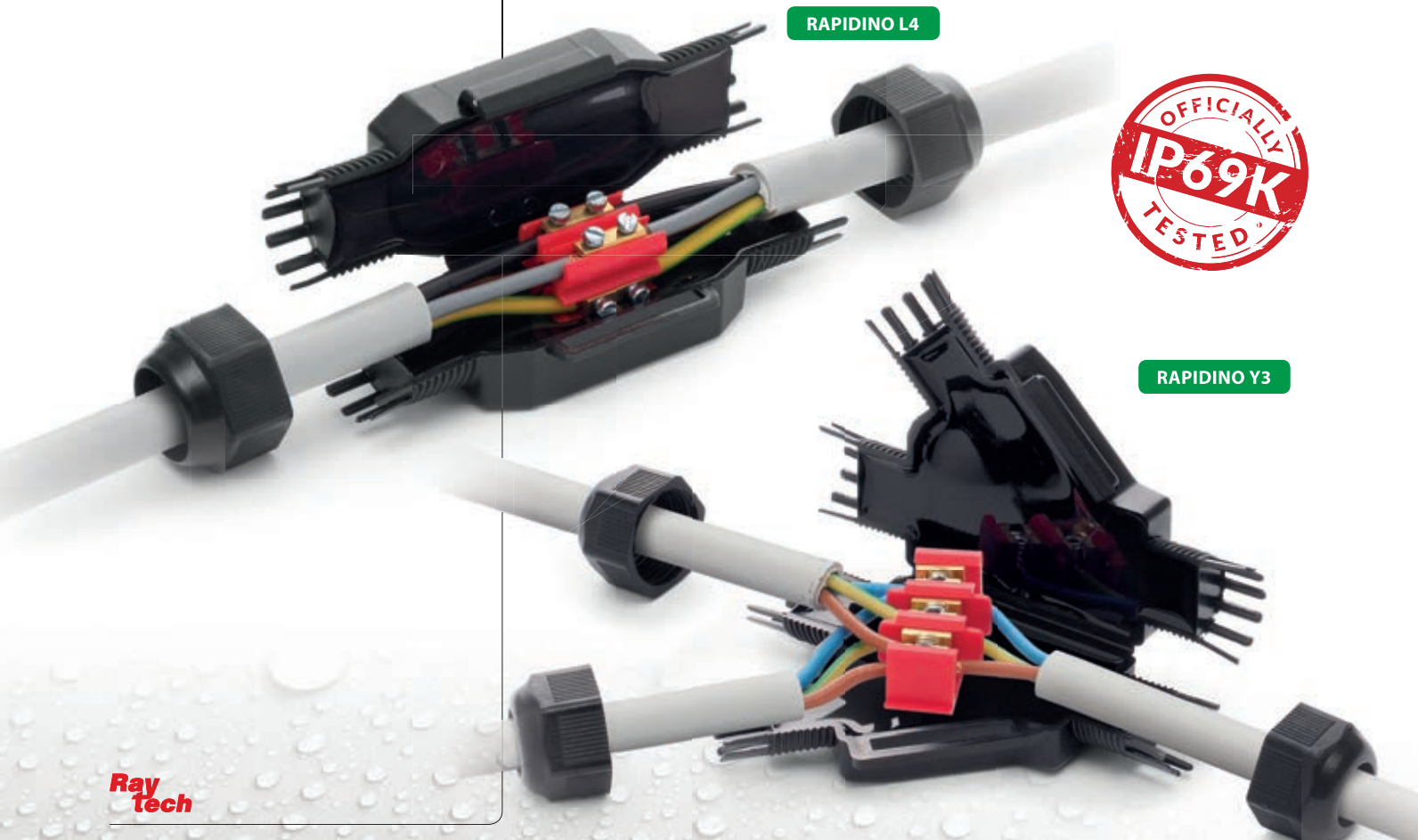



PRE-FILLED WITH GEL

for integrated connections

**Mini Rapid Joint IP68 L**

Product	Formation	Connector	Cable formation max (N° x mm²)	Ø cables min - max (mm)	Pieces / Pack	Dimensions (mm)
Rapidino IP68 L2			2 x 2,5	6 - 10	3 pcs / Box	75 x 28 x 19
Rapidino IP68 L3			3 x 2,5	8 - 13	3 pcs / Box	80 x 36 x 23
Rapidino IP68 L4			4 x 4	10 - 16	1 pc / Box	125 x 43 x 35

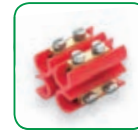
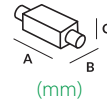

**Mini Rapid Joint IP68 Y**

Product	Formation	Connector	Through	Branch	Ø cables min - max (mm)	Pieces / Pack	Dimensions (mm)
Rapidino IP68 Y1			1 x 4 1 x 2,5	1 x 1,5 1 x 2,5	6 - 10	2 pcs / Box	85 x 55 x 22
Rapidino IP68 Y3			3 x 4 3 x 2,5	3 x 1,5 3 x 2,5	8 - 13	1 pc / Box	110 x 72 x 25





PRE-FILLED WITH GEL

for integrated connections

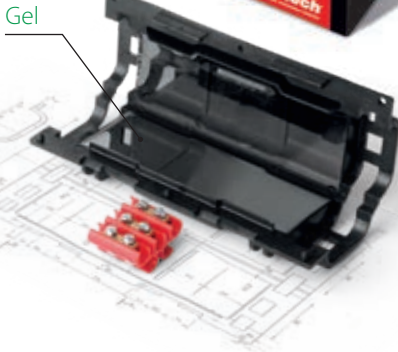

**Electrical performance:** CEI EN 50393  
(with testing under water head  
and water between the cable cores)  
Class 2 in accordance with CEI 64-8.

**No flame propagation:**  
CEI 20-35 • IEC 60332-1 HD405-1  
(as applicable)

Low smoke and toxic and  
corrosive gas emissions

**Gel:** UL 94-HB 

**Case:** UL 94-V2

Operating temperature 

Installation temperature:   
-40°C / +50°C

**IPX8**  
OFFICIALLY  
TESTED 



# Super Klik

Range of fast gel pre-filled straight or branch type joints for 0.6/1 kV multi core cables of up to 5 conductors.

The combination of the primary insulation in a cross-linked polymer gel and the highly robust insulating plastic case makes this a Class 2 joint defined by CEI 64-8. The joint has been tested in accordance with the main international specifications, with repeated flexing and torsion tests and immersion in water, it has been declared as conforming to the mechanical, electrical and sealing specifications required for plastic cable accessories. The joint and its components have an unlimited shelf life, they are chemically inert and therefore completely safe; the connections are re-entrable even after long working periods. Made of self-extinguishing components the joint is flame retardant. For cables at 90°C working temperature.

- Complete with isolated terminal blocks
- For straight and branch connections
- For all types of application, including submersible
- Re-accessible and with no shelf life
- Flame retardant
- Non toxic and safe



# SUPERCLIK



PRE-FILLED WITH GEL  
for integrated connections

## Super Klik Mini

Product	Cable formation and conductor cross sections (n° x mm <sup>2</sup> )			Max cables Ø (mm)	A x B x C (mm)
	Straight Connections In line	Branch connections T B			
Super Klik Mini L	3 x 0,5 - 1,5	-	-	10	71 x 38 x 23
Super Klik Mini Y	-	1 x 2,5 - 6	1 x 2,5	10	71 x 38 x 23

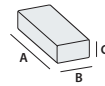

T: Through cable - B: Branch cable

**New**



## Super Klik

Product	Cable formation and conductor cross sections (n° x mm <sup>2</sup> )			Max cables Ø (mm)	A x B x C (mm)
	Straight Connections In line	Branch connections T B			
Super Klik 0	3 x 1,5 - 6	3 x 1,5 - 4	3 x 1,5 - 2,5	14	95 x 43 x 28

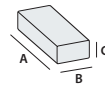

T: Through cable - B: Branch cable



Product	In line	T	B	Ø (mm)	(mm)
Super Klik 1	2 x 1,5 - 6	2 x 4	2 x 2,5	20,5	150 x 56 x 30
	3 x 1,5 - 6	3 x 4	3 x 2,5		
	4 x 1,5 - 6	4 x 4	4 x 2,5		
	5 x 1,5 - 6	5 x 4	5 x 2,5		

T: Through cable - B: Branch cable

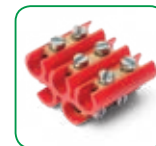

Product	In line	T	B	Ø (mm)	(mm)
Super Klik 2	2 x 4 - 16	2 x 10	2 x 6	30	220 x 85 x 46
	3 x 4 - 16	3 x 10	3 x 6		
	4 x 4 - 16	4 x 10	4 x 6		
	5 x 4 - 16	5 x 10	5 x 6		

T: Through cable - B: Branch cable

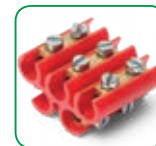

Product	In line	T	B	Ø (mm)	(mm)
Super Klik 3	-	2 x 4 - 25	2 x 1,5 - 16	30	220 x 85 x 46
	-	3 x 4 - 25	3 x 1,5 - 16		
	-	4 x 4 - 25	4 x 1,5 - 16		

T: Through cable - B: Branch cable





PRE-FILLED WITH GEL  
for integrated connections



**Electrical performance:**

CEI EN 50393  
(with testing under water head  
and water between the cable cores)  
Class 2 in accordance with CEI 64-8.

**No flame propagation:**

CEI 20-35 • IEC 60332-1 HD405-1  
(as applicable)  
Low smoke and toxic and  
corrosive gas emissions

**Gel:** UL 94-HB 

**Casing mix:** UL 94-V2

**Degree of protection:** IPX8

Operating temperature 

Installation temperature:   
-40°C / +50°C

**IPX8**  
OFFICIALLY  
TESTED 

# King Joint

Range of fast gel pre-filled straight or branch type joints for 0.6/1 kV multi core cables of up to 5 conductors.

The primary insulation, consisting of a cross-linked polymer gel and extremely strong plastic insulating housing, make the Class 2, in accordance with the definitions contained in CEI Regulation 64-8. The joint, tested in accordance with the most important international specifications with repeated bending and twisting cycles and immersion in water, was found to comply with the mechanical, electrical and sealing requirements necessary for accessories for plastic cables. The joint and its components have no self life, are chemically inert and therefore completely safe; the conductor connections are re-accessible even after long operating periods. Packaged with self-extinguishing material, it is flame retardant. Suitable for cables with a temperature of +90°C.

- For multicore cables of up to 5 cores
- 5 sector spacers for proper centring of five-core connection
- Complete with screw connectors
- For straight and branch connections, including armoured cable
- For all types of application, including submersible
- Re-accessible and with no shelf life
- Flame retardant
- Non toxic and safe

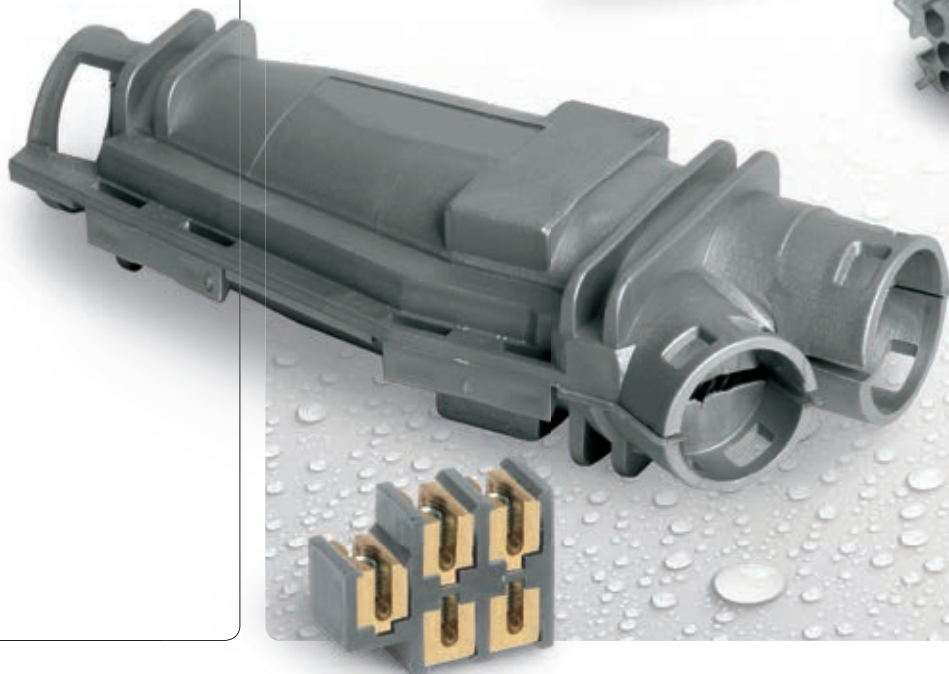
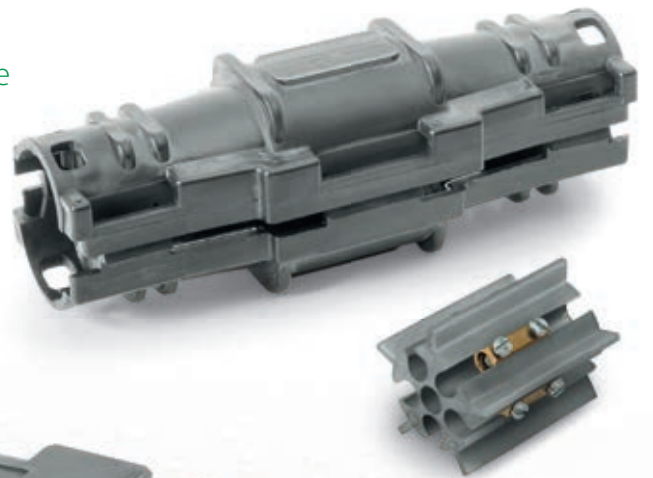



PRE-FILLED WITH GEL

for integrated connections

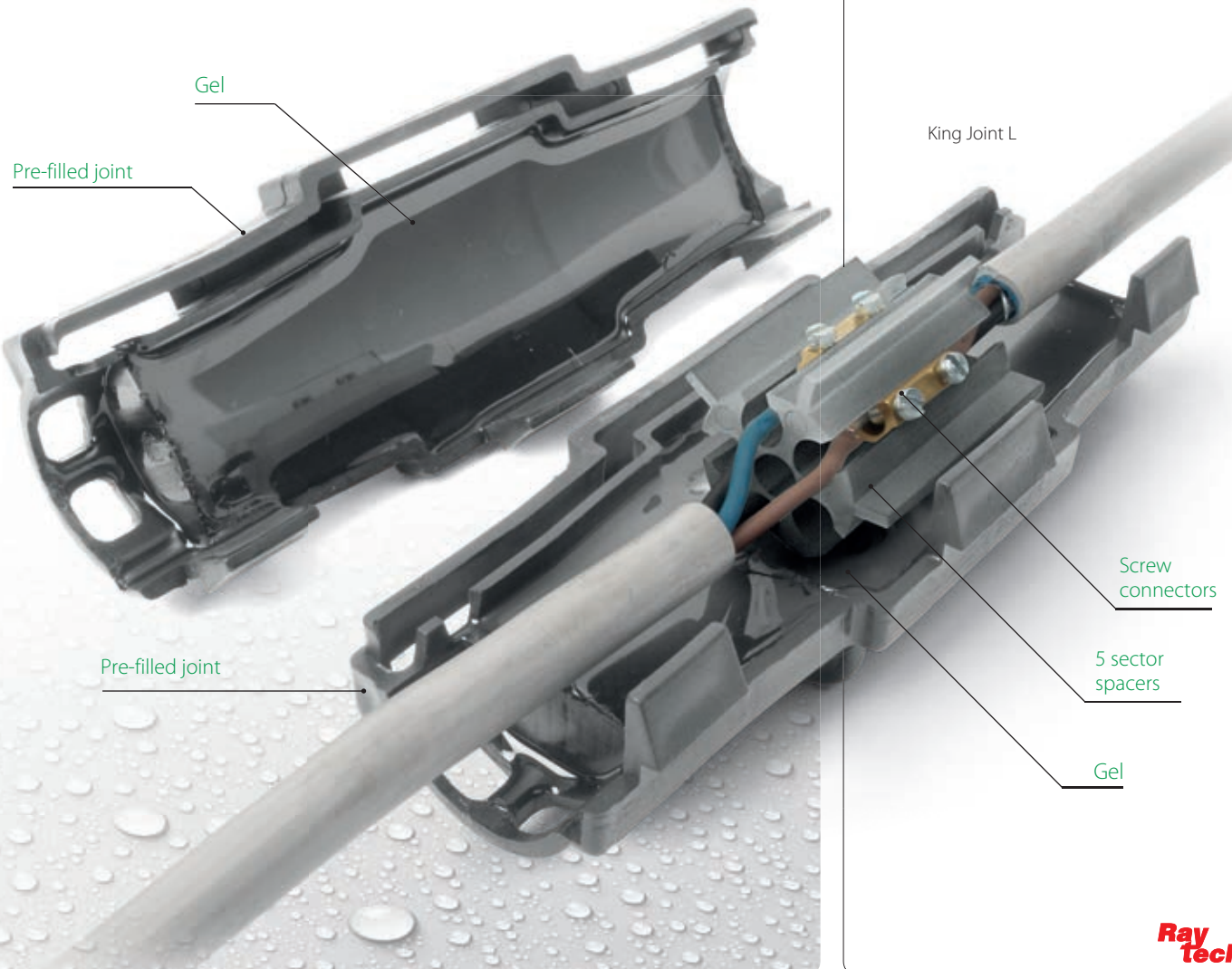
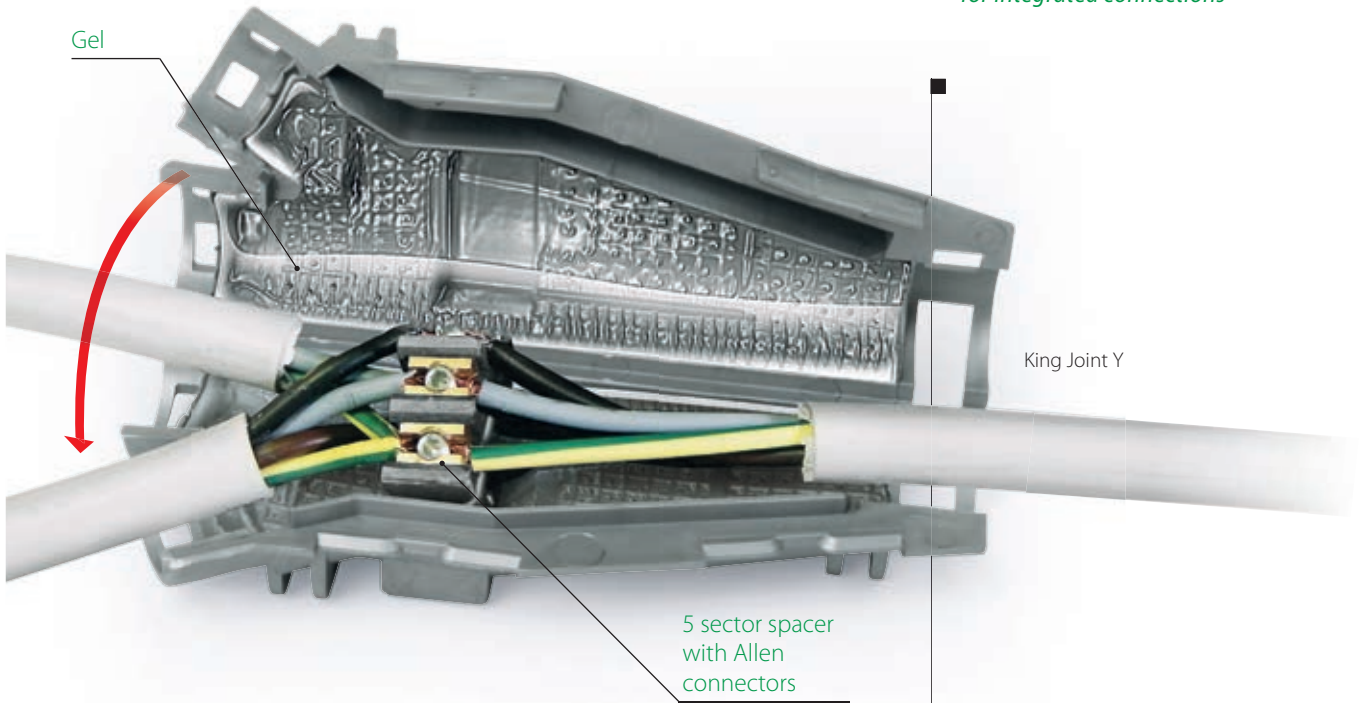





### King Joint L

Straight joints, including armoured cable.

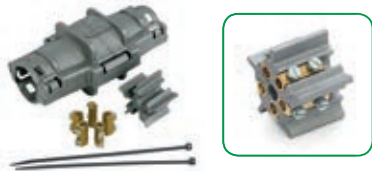
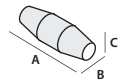

Product	LINE CONNECTIONS Cable formation and conductor cross sections (n° x mm <sup>2</sup> )	Ø max cables (mm)	Dimensions A x B x C (mm)
• King Joint 0 blister	2 x 1,5 - 6	20,5	105 x 55 x 55
	3 x 1,5 - 6		
	4 x 1,5 - 6		
	5 x 1,5 - 6		
• King Joint L6 box	2 x 1,5 - 6	20,5	105 x 55 x 55
	3 x 1,5 - 6		
	4 x 1,5 - 6		
	5 x 1,5 - 6		



Product	STRAIGHT CONNECTIONS Cable formation and conductor cross sections (n° x mm <sup>2</sup> )	Ø max cables (mm)	Dimensions A x B x C (mm)
• King Joint L10 • King Joint L10 - ARM	2 x 2,5 - 10	24	180 x 60 x 60
	3 x 2,5 - 10		
	4 x 2,5 - 10		
	5 x 2,5 - 10		



Product	STRAIGHT CONNECTIONS Cable formation and conductor cross sections (n° x mm <sup>2</sup> )	Ø max cables (mm)	Dimensions A x B x C (mm)
• King Joint L25 • King Joint L25 - ARM	2 x 10 - 25	31	210 x 65 x 65
	3 x 10 - 25		
	4 x 10 - 25		
	5 x 10 - 25		

ARM type joints complete with continuity device suitable for connection to **armoured wire or steel tape cables**.

#### Installation sequence King Joint L

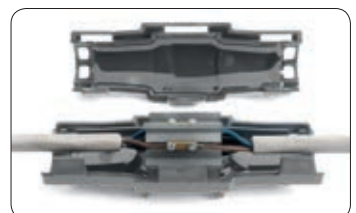



# King Joint Y

Branch joints, including armoured cable.

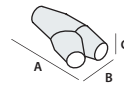

Product	BRANCH CONNECTIONS Cable formation and conductor cross sections (n° x mm <sup>2</sup> )		Ø max cables (mm)		Dimensions A x B x C (mm)
	T	B	T	B	
• King Joint Y6 • King Joint Y6 - ARM	2 x 1,5 - 6	2 x 1,5 - 4	22,5	18,5	138 x 60 x 37
	3 x 1,5 - 6	3 x 1,5 - 4			
	4 x 1,5 - 6	4 x 1,5 - 4			
	5 x 1,5 - 6	5 x 1,5 - 4			

T: Through cable - B: Branch cable



Product	BRANCH CONNECTIONS Cable formation and conductor cross sections (n° x mm <sup>2</sup> )		Ø max cables (mm)		Dimensions A x B x C (mm)
	T	B	T	B	
• King Joint Y16 • King Joint Y16 - ARM	2 x 4 - 16	2 x 1,5 - 4	26	18,5	194 x 74 x 43
	3 x 4 - 16	3 x 1,5 - 4			
	4 x 4 - 16*	4 x 1,5 - 4			
	5 x 4 - 16*	5 x 1,5 - 4			

T: Through cable - B: Branch cable

\* For armoured cables max conductor cross section 10 mm<sup>2</sup>.



Product	BRANCH CONNECTIONS Cable formation and conductor cross sections (n° x mm <sup>2</sup> )		Ø max cables (mm)		Dimensions A x B x C (mm)
	T	B	T	B	
• King Joint Y35 • King Joint Y35 - ARM	2 x 10 - 35	2 x 1,5 - 6	36	26	290 x 105 x 51
	3 x 10 - 35	3 x 1,5 - 6			
	4 x 10 - 35*	4 x 1,5 - 6			

T: Through cable - B: Branch cable

\* For armoured cables max conductor cross section 25 mm<sup>2</sup>.

ARM type joints complete with continuity device suitable for connection to **armoured wire or steel tape cables**.

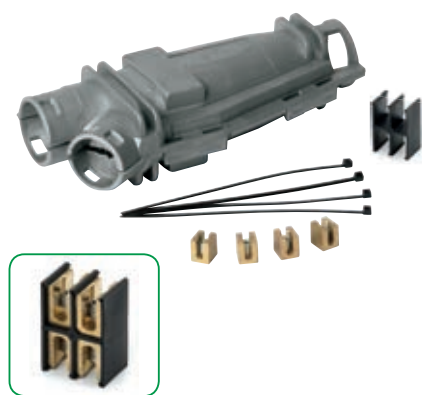

## Installation sequence King Joint Y

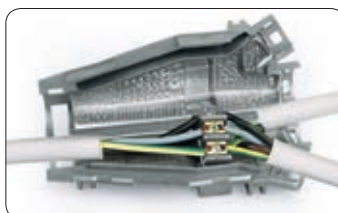
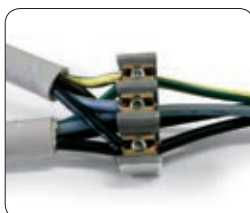



**Electrical performance:** CEI EN 50393  
(with testing under water head and water between the cable cores)  
Class 2 in accordance with CEI 64-8.

**No flame propagation:**  
CEI 20-35 • IEC 60332-1 • HD405-1  
(as applicable)  
Low smoke and toxic and corrosive gas emissions

**Gel:** UL 94-HB 

**Casing mix:** UL 94-V2

**Degree of protection:** IP68

Operating temperature 

Installation temperature:   
-40°C / +50°C

# Rapid Joint

Radial closing gel pre-filled joint for extruded insulation cables up to 1 kV.

Made with self-extinguishing material, flame retardant, for cables at 90°C working temperature. The radial closing system facilitates joint application, making them re-enterable only by means of a tool.

- For straight connections (in line)
- With suitable spacers
- For all types of application, including submersible
- Wide range of cable formations
- Non-toxic, with no expiry date

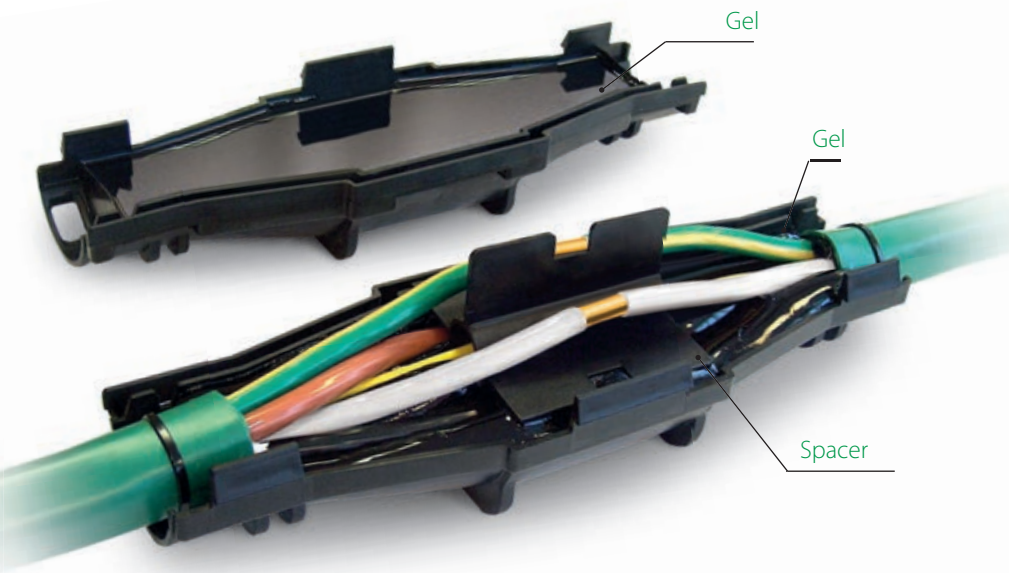

## Rapid Joint

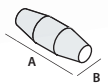

For <b>COPPER</b> cables	Cable formation and conductor cross sections (n° x mm <sup>2</sup> )				With optical fibre separator 4x	Dimensions A x B (mm)
	1x	2x	3x	4x		
<b>Product</b>						
Rapid Joint L6	1,5 - 50	1,5 - 10	1,5 - 10	1,5 - 6	-	105 x 55
Rapid Joint L10	2,5 - 150	2,5 - 25	2,5 - 16	2,5 - 16	-	180 x 60
Rapid Joint L25	120 - 240	6 - 50	6 - 35	4 - 35	-	210 x 65
Rapid Joint L95	185 - 400	35 - 95	25 - 70	25 - 70	16 - 50	320 x 100
For <b>ALUMINIUM</b> cables	1x	2x	3x	4x	4x	(mm)
Rapid Joint L 25	120 - 150	16 - 35	10 - 25	10 - 25	-	210 x 65
Rapid Joint L 95	185 - 400	35 - 95	25 - 70	25 - 70	16 - 50	320 x 100



**PRE-FILLED WITH GEL**

for free connections

## Rapid Joint S/ARM

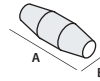

Product	Cable formation and conductor cross sections (n° x mm <sup>2</sup> )				With optical fibre separator 4x	Dimensions A x B (mm)
	1x	2x	3x	4x		
Rapid Joint L 10-S	2,5 - 120	2,5 - 10	2,5 - 10	2,5 - 10	-	180 x 60
Rapid Joint L 25-S	120 - 185	16 - 25	10 - 25	10 - 25	-	210 x 65
Rapid Joint L 95-S	240 - 400	35 - 95	25 - 70	25 - 70	16 - 50	320 x 100

Product	Cable formation and conductor cross sections (n° x mm <sup>2</sup> )				With optical fibre separator 4x	Dimensions A x B (mm)
	2x	3x	4x	4x		
Rapid Joint L 10-ARM	2,5 - 10	2,5 - 10	2,5 - 10	-	-	180 x 60
Rapid Joint L 25-ARM	16 - 25	10 - 25	10 - 25	-	-	210 x 65
Rapid Joint L 95-ARM	35 - 95	25 - 70	25 - 70	16 - 50	-	320 x 100

For screened or tape or wire armoured cables



Joint supplied with armour continuity device

## Rapid Joint LS

Product	Conductors (mm <sup>2</sup> )	Cable formation (n° conductors)										Dimensions A x B (mm)	
		5x	7x	10x	12x	16x	19x	24x	40x	75x	100x		
Rapid Joint-LS1	1,5 2,5	•	•	•	•	•	•						180 x 60
Rapid Joint-LS2	1,5 2,5			•	•	•	•	•	•				210 x 65
Rapid Joint-LS3	1,5 2,5						•	•	•	•	•	•	320 x 100

For signalling and control cables



## Rapid Joint T

UNSCREENED	SCREENED	N° pairs for conductor cross sections (n° x mm <sup>2</sup> )	Dimensions A x B (mm)
Product	Product		
Rapid Joint-T26	Rapid Joint-TS26	(1 - 26) x (0,5 - 0,6)	180 x 60
Rapid Joint-T61	Rapid Joint-TS61	(30 + 1 - 64 + 1) x (0,5 - 0,6)	210 x 65
Rapid Joint-T101	Rapid Joint-TS101	(60 + 1 - 100 + 1) x (0,5 - 0,6)	320 x 100

Straight joints for telephone cables



## Rapid Joint System Fast RP

Straight joint + Shear bolt connectors.

Product	Cable formation from 2x a 4x (n° x mm <sup>2</sup> )	Dimensions A x B (mm)
Rapid Joint L 10 RP	1,5 - 10	180 x 60
Rapid Joint L 25 RP	10 - 25	210 x 65
Rapid Joint L 95 RP	35 - 95	320 x 100



### Shear bolt connectors

Product	Aluminium cross sections (mm <sup>2</sup> )	Copper cross sections (mm <sup>2</sup> )	Breakaway torque (Nm)	Dimensions (mm)		
				L	D	d
Ray-TTF 1,5/16	10 - 16	1,5 - 16	4	30	12	6,1
Ray-TTF 10/35	10 - 35	10 - 35	10	36	16	9,0
Ray-TTF 25/50	25 - 50	25 - 50	12	36	18	10,0
Ray-TTF 35/150	35 - 150	35 - 150	30	70	28	17,0

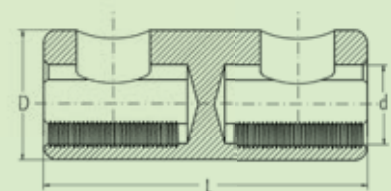



# JOINTS

## PRE-FILLED WITH GEL

for free connections

# LV

# Clík Fire

Straight or branch joint pre-filled with gel, for multi core cables up to 4 cores.

### Electrical performance:

CEI EN 50393 with connectors complying with EN 61238-1 (with testing under water head and water between the cable cores) Class 2 in accordance with CEI 64-8.

### No flame propagation:

CEI 20-35 • IEC 60332-1 • HD405-1 (as applicable)

Gel: UL 94-HB 

Casing mix: UL 94-V2

Degree of protection: IPX8

Operating temperature 

Installation temperature:  -40°C / +50°C



RINA

Installation temperature:



## Straight or branch multi core joints.

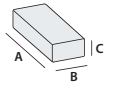

Product	Cable formation and conductor cross sections (n° x mm <sup>2</sup> )		Ø max cables (mm)		Dimensions A x B x C (mm)
	Through or straight	1 or 2 branch cables	Through or straight	Branch	
CLIK 0 Fire	1 x 2,5 - 50	1 x 1,5 - 10	16	10	95 x 43 x 28
	2 x 2,5 - 6	2 x 1,5			
CLIK 1 Fire	1 x 6 - 95	1 x 1,5 - 35	20,5	15	150 x 56 x 30
	2 x 1,5 - 16	2 x 1,5 - 6			
	3 x 1,5 - 10	3 x 1,5 - 6			
	4 x 1,5 - 10	4 x 1,5 - 4			
CLIK 2 Fire	1 x 50 - 185	1 x 16 - 185	30	29	220 x 85 x 46
	2 x 10 - 35	2 x 1,5 - 35			
	3 x 6 - 35	3 x 1,5 - 35			
	4 x 6 - 35	4 x 1,5 - 16			



## Branch joints with 30° output.

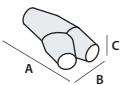

Product	Through	Branch	Through	Branch	Dimensions (mm)
	CLIK 2000 Fire	1 x 2,5 - 25			
CLIK 2001 Fire	1 x 6 - 95	1 x 1,5 - 70	22,5	18,5	138 x 60 x 37
	2 x 1,5 - 16	2 x 1,5 - 10			
	3 x 2,5 - 16	3 x 1,5 - 10			
	4 x 2,5 - 10	4 x 1,5 - 6			
CLIK 2002 Fire	1 x 50 - 150	1 x 1,5 - 70	26	18,5	194 x 74 x 43
	2 x 1,5 - 25	2 x 1,5 - 10			
	3 x 4 - 25	3 x 1,5 - 10			
	4 x 4 - 16	4 x 1,5 - 6			
CLIK 2003 Fire	1 x 150 - 240	1 x 50 - 120	36	26	290 x 105 x 51
	2 x 16 - 50	2 x 10 - 25			
	3 x 16 - 50	3 x 10 - 25			
	4 x 16 - 50	4 x 6 - 16			

Sections evaluated on the base extruded 0,6 1 kV cable.

Ray Tech



## PRE-FILLED WITH GEL

for free connections

## Clik Fire - A2A

Main line branch joint for parallel type public lighting systems.

Branch joints from main to main cable, from main to pole rise, from overhead line to pole equipment, from pre-assembled cable to pole equipment, of a type certified by Azienda Elettrica Milanese (A2A, ex AEM). Accessories are complete with mantel-type, pre-insulated Allen screw connectors and, for installations with traps, with the specific protection monitor plate. Joints are non-toxic, with no shelf life and re-enterable.

Product	Approval code	Branch type	Through cable (n° x mm <sup>2</sup> )	Branch cable (n° x mm <sup>2</sup> )
CLIK 2 Fire Dor/Palo	E 27.012	Main / Pole	RG7R 2 x 1 x 16	FG7OR 2 x 2,5
CLIK 1 Fire Dor/Dor	E 27.013	Main / Main	RG7R 4 x 1 x 16	RG7R 4 x 1 x 16
CLIK 1 Fire Aer/Dap	E 27.014	Overhead line / Equipment	UG7R 2 x 1 x 16	FG7R 2 x 1 x 4
CLIK 2 Fire Prec/Dap	E 27.015	Pre-assembled / Equipment	RE4E4X 2 x 1 x 10	FG7OR 2 x 2,5



**Electrical performance:**  
CEI EN 50393 • CEI 20-33 • IP 0033 (A2A)

**No flame propagation:**  
CEI 20-35 • IEC 60332-1 HD405-1  
A2A certified (as applicable)

**Gel:** UL 94-HB

**Casing mix:** UL 94-V2

**Degree of protection:** IPX8

Operating temperature

Installation temperature:  
-40°C / +50°C



## Clik Fire - A2A (Fuse)

Branch joint from main to pole rise, with protection fuse.

Branch joints from main to pole rise complete with disconnectable fuse holder and fuse with signal indicating intervention. Accessories are complete with mantel-type, pre-insulated Allen screw connectors and, for installations with traps, with the specific protection monitor plate. Joints are non-toxic, with no shelf life and re-enterable and flame retardant.

Product	Fuse inserted	Branch type	Through cable (n° x mm <sup>2</sup> )	Branch cable (n° x mm <sup>2</sup> )
CLIK 2 Fire Dor/Palo Fuse	16 A	Main / Pole	RG7R 4 x 1 x 16	FG7OR 2 x 2,5



**Electrical performance:**  
CEI EN 50393 • CEI 20-33 • IP 0033 (A2A)

**No flame propagation:**  
CEI 20-35 • IEC 60332-1 HD405-1  
A2A certified (as applicable)

**Gel:** UL 94-HB

**Casing mix:** UL 94-V2

**Degree of protection:** IPX8

Operating temperature

Installation temperature:  
-40°C / +50°C



**Electrical performance:**  
CEI EN 50393 with connectors  
complying with EN 61238-1  
(with testing under water head  
and water between the cable cores)  
Class 2 in accordance with CEI 64-8.

**Gel:** UL 94-HB

**Degree of protection:** IP68

Operating temperature  90°

Installation temperature:  -15°C / +55°C

# Magic Power Joint

Straight or branch joint with Magic Power Gel for extruded insulation cables up to 1 kV.

Joints for extruded cables F(R)G7OR 0.6/1 kV. Easy installation, composed of two anti-fracture plastic shells, to be filled with non-toxic quick cross linking bicomponent insulation such as Magic Power Gel. Suitable for installation in traps, channels or directly underground or under water. Non-toxic, safe, light and re-enterable. Thanks to the softness of the insulation, they are able to absorb external shock without cracking or fracturing. The extreme stickiness of the insulation together with its softness allow it to transmit water pressure for installation even at high depths.

## RE-ENTERABLE



## REMOVABLE



## INSPECTIONABLE



## REUSABLE



- Re-enterable and inspectable joint
- Insulated with **Magic Power Gel**, the innovative self-amalgamating gel
- For installations even in harsh conditions and high depths!
- Extremely adherent and tight sealing
- Non-toxic and safe
- No shelf life



In 15 minutes, the gel is cross-linked and **Magic Power Joint** is ready!



# Magic Power Joint L

Straight joint for 0.6/1 kV extruded cables.

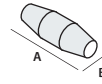

Product	Cable formation and conductor cross sections (n° x mm <sup>2</sup> )				Dimensions A x B (mm)
	1x	2x	3x	4x	
Magic P Joint L10	2,5 - 50	1,5 - 10	1,5 - 10	1,5 - 10 *	180 x 50
Magic P Joint L25	16 - 150	4 - 25	4 - 25	2,5 - 25	215 x 55
Magic P Joint L35	16 - 185	16 - 35	16 - 35	16 - 35	232 x 70
Magic P Joint L50	50 - 300	16 - 50	16 - 50	16 - 50	266 x 72
Magic P Joint L95	120 - 400	25 - 95	25 - 95	25 - 95	330 x 75
Magic P Joint L120	240 - 500	70 - 120	70 - 120	50 - 120	365 x 95
Magic P Joint L240	400 - 1000	120 - 300	120 - 240	120 - 240	510 x 120
Magic P Joint L300	630 - 2000	240 - 400	240 - 300	240 - 300	760 x 180

Product	Cable formation and conductor cross sections (n° x mm <sup>2</sup> )				Dimensions A x B (mm)
	1x	2x	3x	4x	
Magic P Joint L50	16 - 150	16 - 25	16 - 25	16 - 25	266 x 72
Magic P Joint L120	185 - 400	25 - 95	25 - 95	25 - 95	365 x 95
Magic P Joint L240	400 - 630	95 - 185	95 - 185	95 - 185	510 x 120
Magic P Joint L300	630 - 2000	185 - 300	185 - 300	185 - 300	760 x 180

\* Magic Power Joint 10 suggested for cable diameters smaller than 16 mm.



# Magic Power Joint Y

Branch joint for 0.6/1 kV extruded cables.

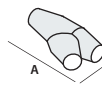

Product	Cable formation and conductor cross sections (n° x mm <sup>2</sup> )								Dimensions A x B (mm)
	1x		2x		3x		4x		
	T	B	T	B	T	B	T	B	
Magic P Joint Y6	4 - 50	4 - 50	4 - 10	4 - 10	2,5 - 6	2,5 - 6	2,5 - 6	2,5 - 6	180 x 90
Magic P Joint Y25	50 - 150	50 - 150	10 - 25	10 - 25	6 - 25	6 - 16	6 - 25	6 - 10	220 x 105
Magic P Joint Y95	120 - 400	95 - 240	25 - 95	16 - 50	25 - 95	16 - 50	25 - 95	10 - 50	315 x 115
Magic P Joint Y240*	240 - 630	240 - 630	95 - 240	50 - 240	95 - 240	50 - 240	95 - 240	50 - 240	600 x 285

T: Through - B: Branch

\* also for aluminium cables.

Magic Power Joint Y







## Magic Power Joint L-S

Straight joint for 0.6/1 kV screened extruded cables.

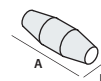

Product	Cable formation and conductor cross sections (n° x mm <sup>2</sup> )				Dimensions A x B (mm)
	1x	2x	3x	4x	
Magic P Joint L10-S	2,5 - 50	1,5 - 10	1,5 - 6	1,5 - 6	180 x 50
Magic P Joint L25-S	16 - 120	4 - 25	4 - 16	2,5 - 16	215 x 55
Magic P Joint L35-S	16 - 185	16 - 35	16 - 25	16 - 25	232 x 70
Magic P Joint L50-S	50 - 240	16 - 50	16 - 50	16 - 50	266 x 72
Magic P Joint L120-S	240 - 500	70 - 120	70 - 120	50 - 95	365 x 95
Magic P Joint L240-S	400 - 1000	120 - 300	120 - 185	120 - 185	510 x 120
Magic P Joint L300-S	630 - 2000	240 - 400	240 - 300	240 - 300	760 x 180

For ALUMINIUM cables	1x	2x	3x	4x	(mm)
Magic P Joint L50-S	16 - 150	16 - 25	16 - 25	16 - 25	266 x 72
Magic P Joint L120-S	185 - 400	25 - 95	25 - 95	25 - 95	365 x 95
Magic P Joint L240-S	400 - 630	95 - 185	95 - 185	95 - 185	510 x 120
Magic P Joint L300-S	630 - 2000	185 - 300	185 - 300	185 - 300	760 x 180



## Magic Power Joint Y-S

Branch joint for 0.6/1 kV screened extruded cables.

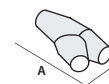

Product	Cable formation and conductor cross sections (n° x mm <sup>2</sup> )								Dimensions A x B (mm)
	1x		2x		3x		4x		
	T	B	T	B	T	B	T	B	
Magic P Joint Y6-S	4 - 35	4 - 35	4 - 10	4 - 10	2,5 - 6	2,5 - 6	2,5 - 6	2,5 - 6	180 x 90
Magic P Joint Y25-S	35 - 120	35 - 120	10 - 25	10 - 25	6 - 16	6 - 16	6 - 16	6 - 10	220 x 105
Magic P Joint Y95-S	95 - 300	70 - 150	25 - 95	16 - 50	16 - 70	16 - 35	16 - 50	10 - 35	315 x 115
Magic P Joint Y240-S*	240 - 630	150 - 630	95 - 240	50 - 240	70 - 240	35 - 240	50 - 240	35 - 240	600 x 285

T : Through - B : Branch  
\* also for aluminium cables.



## Magic Power Joint L-ARM

Straight joint for 0,6/1 kV extruded cables with tape, wire or plate armouring.

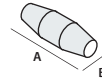

For <b>COPPER</b> cables		Cable formation and conductor cross sections (n° x mm <sup>2</sup> )			Dimensions A x B (mm)
Product	2x	3x	4x		
Magic P Joint L10-ARM	1,5 - 10	1,5 - 6	1,5 - 6	180 x 50	
Magic P Joint L25-ARM	4 - 25	4 - 16	2,5 - 16	215 x 55	
Magic P Joint L35-ARM	16 - 35	16 - 25	16 - 25	232 x 70	
Magic P Joint L50-ARM	16 - 50	16 - 50	16 - 50	266 x 72	
Magic P Joint L120-ARM	70 - 120	70 - 120	50 - 95	365 x 95	
Magic P Joint L240-ARM	120 - 300	120 - 185	120 - 185	510 x 120	
Magic P Joint L300-ARM	240 - 400	240 - 300	240 - 300	760 x 180	

For <b>ALUMINIUM</b> cables		2x	3x	4x	(mm)
Magic P Joint L50-ARM	16 - 25	16 - 25	16 - 25	266 x 72	
Magic P Joint L120-ARM	25 - 95	25 - 95	25 - 95	365 x 95	
Magic P Joint L240-ARM	95 - 185	95 - 185	95 - 185	510 x 120	
Magic P Joint L300-ARM	185 - 300	185 - 300	185 - 300	760 x 180	



## Magic Power Joint Y-ARM

Branch joint for 0,6/1 kV extruded cables with tape, wire or plate armouring.

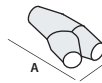

For WIRE armoured <b>COPPER</b> cables		Cable formation and conductor cross sections (n° x mm <sup>2</sup> )						Dimensions A x B (mm)
Product	2x		3x		4x			
	T	B	T	B	T	B		
Magic P Joint Y6-ARM-F	4 - 10	4 - 10	2,5 - 6	2,5 - 6	2,5 - 6	2,5 - 6	180 x 90	
Magic P Joint Y25-ARM-F	10 - 25	10 - 25	6 - 16	6 - 16	6 - 16	6 - 10	220 x 105	
Magic P Joint Y95-ARM-F	25 - 70	16 - 50	25 - 70	16 - 35	25 - 50	10 - 35	315 x 115	
Magic P Joint Y240-ARM-F*	70 - 240	50 - 240	70 - 240	35 - 240	50 - 240	35 - 240	600 x 285	

For TAPE, WIRE OR PLATE armoured <b>COPPER</b> cables		2x		3x		4x		(mm)
Product	T	B	T	B	T	B		
	Magic P Joint Y6-ARM	4 - 10	4 - 10	2,5 - 6	2,5 - 6	2,5 - 6	2,5 - 6	180 x 90
Magic P Joint Y25-ARM	10 - 25	10 - 25	6 - 16	6 - 16	6 - 16	6 - 10	220 x 105	
Magic P Joint Y95-ARM	25 - 70	16 - 50	25 - 70	16 - 35	25 - 50	10 - 35	315 x 115	
Magic P Joint Y240-ARM*	70 - 240	50 - 240	70 - 240	35 - 240	50 - 240	35 - 240	600 x 285	

T : Through - B : Branch

\* also for aluminium cables.





## Magic Power Joint-SL

Straight joint for signaling and control multi core extruded 0,6/1 kV cables.

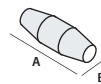

Product	Conductor cross sections (mm <sup>2</sup> )	Cable formation (n° conductors)											Dimensions A x B (mm)				
		5x	7x	10x	12x	16x	19x	24x	40x	75x	100x	250x		500x			
Magic P Joint SL11	1,5 2,5	•	•	•	•	•											180 x 50
Magic P Joint SL12	1,5 2,5			•	•	•	•	•									215 x 55
Magic P Joint SL13	1,5 2,5					•	•	•	•								266 x 72
Magic P Joint SL14	1,5 2,5								•	•	•						330 x 75
Magic P Joint SL15	1,5 2,5									•	•	•					365 x 95
Magic P Joint SL16	1,5 2,5										•	•	•				510 x 120
Magic P Joint SL17	1,5 2,5											•	•	•			760 x 180



## Magic Power Joint-SY

Branch joint for signaling and control multi core extruded 0,6/1 kV cables.

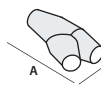

Product	Conductor cross sections (mm <sup>2</sup> )	Cable formation (n° conductors)											Dimensions A x B (mm)				
		5x	7x	10x	12x	16x	19x	24x	40x	75x	100x	250x		500x			
Magic P Joint SY1	1,5 2,5	•	•	•	•	•	•										180 x 90
Magic P Joint SY2	1,5 2,5					•	•	•									220 x 105
Magic P Joint SY3	1,5 2,5							•	•	•	•						315 x 115
Magic P Joint SY4	1,5 2,5									•	•	•	•	•			600 x 285



## Magic Power Joint-T e TS

Straight joint for telephone cables.

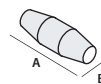

UNscreened	SCREENED	N° pairs per conductor cross sections (n° x mm <sup>2</sup> )	Dimensions A x B (mm)
Product	Product		
Magic P Joint T16	Magic P Joint TS16	1 - 16 x 0,5 - 0,6	180 x 50
Magic P Joint T25	Magic P Joint TS25	16 - 25 x 0,5 - 0,6	215 x 55
Magic P Joint T35	Magic P Joint TS35	25 - 35 x 0,5 - 0,6	266 x 72
Magic P Joint T40	Magic P Joint TS40	35 - 40 x 0,5 - 0,6	330 x 75
Magic P Joint T64	Magic P Joint TS64	40 - 64 x 0,5 - 0,6	365 x 95
Magic P Joint T500	Magic P Joint TS500	60 - 500 x 0,5 - 0,6	510 x 120
Magic P Joint T1000	Magic P Joint TS1000	450 - 1000 x 0,5 - 0,6	760 x 180

## Magic Power Joint System Plus L

Straight joint + Five-core spacer.

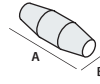

Product	Cable formation and conductor cross sections (n° x mm <sup>2</sup> )				Dimensions A x B (mm)
	2x	3x	4x	5x	
Magic P Joint SP L6	1,5 - 6	1,5 - 6	1,5 - 6	1,5 - 6	180 x 50
Magic P Joint SP L16	4 - 16	4 - 16	4 - 16	4 - 16	215 x 55
Magic P Joint SP L25	4 - 25	4 - 25	4 - 25	4 - 25	215 x 65



## Magic Power Joint System Plus Y

Y Branch joint + Five-core spacer.

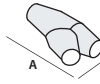

Product	Cable formation and conductor cross sections (n° x mm <sup>2</sup> )								Dimensions A x B (mm)
	2x		3x		4x		5x		
	T	B	T	B	T	B	T	B	
Magic P Joint SP Y6	1,5-6	1,5-4	1,5-6	1,5-4	1,5-6	1,5-4	1,5-6	1,5-4	180 x 90
Magic P Joint SP Y16	4-16	1,5-4	4-16	1,5-4	4-16	1,5-4	4-16	1,5-4	220 x 105

T: Through - B: Branch



## Magic Power Joint System Plus T

T Branch joint + Four-core spacer.

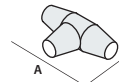

Product	Cable formation and conductor cross sections (n° x mm <sup>2</sup> )						Dimensions A x B (mm)
	2x		3x		4x		
	T	B	T	B	T	B	
Magic P Joint SP T35	6 - 35	1,5 - 10	6 - 35	1,5 - 10	6 - 35	1,5 - 10	305 x 155

T: Through - B: Branch



## Magic Power Joint System Fast RP

Straight joint + Shear bolt connectors.

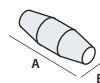

Product	Cable formation from 2x a 4x (n° x mm <sup>2</sup> )	Dimensions A x B (mm)
Magic P Joint L 35- RP/16	1,5 - 16	232 x 70
Magic P Joint L 35- RP/35	10 - 35	232 x 70
Magic P Joint L 50- RP/50	25 - 50	266 x 72
Magic P Joint L 120- RP/120	35 - 120	365 x 95
Magic P Joint L 240- RP/150	35 - 150	510 x 120





**Electrical performance:**  
CEI EN 50393 with connectors  
complying with EN 61238-1  
(with testing under water head  
and water between the cable cores)  
Class 2 in accordance with CEI 64-8.

**Gel:** UL 94-HB

**Degree of protection:** IP68

Operating  
temperature

Installation temperature:  
-15°C / +55°C

# Magic Joint

Straight or branch joint with Magic Gel filling gel for extruded insulation cables up to 1 kV.

Joints for extruded cables F(R)G7OR 0.6/1 kV. Easy installation, composed of two anti-fracture plastic shells, to be filled with non-toxic quick cross linking bicomponent insulation with no shelf life, Magic Gel type. Suitable for installation in traps, channels or directly underground or under water. Non-toxic, safe, light and re-enterable. Thanks to the softness of the insulation, they are able to absorb external shock without cracking or fracturing. The extreme stickiness of the insulation, together with its softness allow it to transmit water pressure for installation even at high depths. Thanks to the materials used, joints are completely non-toxic, safe, re-enterable even after long periods of operation.

- Quick cross linking gel, (only 10 minutes at 23°C)
- Extremely adherent and tight sealing
- Non-toxic and safe
- No shelf life



### Installation sequence



Slip off the separator.



Mix for a minute.



Pour within a minute.



After 10 minutes,  
Magic joint is ready.



# Magic Joint

Straight joint for 0.6/1 kV extruded cables.

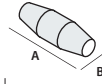

For <b>COPPER</b> cables		Cable formation and conductor cross sections (n° x mm <sup>2</sup> )				Dimensions (mm)
Product	1x	2x	3x	4x		
Magic Joint 4	1,5 - 25	1,5 - 4	1,5 - 4	1,5 - 4	160 x 45	
Magic Joint 10	2,5 - 50	1,5 - 10	1,5 - 10	1,5 - 10 *	180 x 50	
Magic Joint 25	16 - 150	4 - 25	4 - 25	2,5 - 25	215 x 55	
Magic Joint 35	16 - 185	16 - 35	16 - 35	16 - 35	232 x 70	
Magic Joint 50	50 - 300	16 - 50	16 - 50	16 - 50	266 x 72	
Magic Joint 95	120 - 400	25 - 95	25 - 95	25 - 95	330 x 75	
Magic Joint 120	240 - 500	70 - 120	70 - 120	50 - 120	365 x 95	
Magic Joint 240	400 - 1000	120 - 300	120 - 240	120 - 240	510 x 120	
Magic Joint 300	630 - 2000	240 - 400	240 - 300	240 - 300	760 x 180	



For <b>ALUMINIUM</b> cables		1x	2x	3x	4x	(mm)
Magic Joint 50	16 - 150	16 - 25	16 - 25	16 - 25	16 - 25	266 x 72
Magic Joint 120	185 - 400	25 - 95	25 - 95	25 - 95	25 - 95	365 x 95
Magic Joint 240	400 - 630	95 - 185	95 - 185	95 - 185	95 - 185	510 x 120
Magic Joint 300	630 - 2000	185 - 300	185 - 300	185 - 300	185 - 300	760 x 180

\* Magic Joint 10 suggested for cable diameters smaller than 16 mm.

# Magic Joint Y

Branch joint for 0.6/1 kV extruded cables.

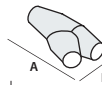

For <b>COPPER</b> cables		Cable formation and conductor cross sections (n° x mm <sup>2</sup> )								Dimensions A x B (mm)
Product	1x		2x		3x		4x			
	T	B	T	B	T	B	T	B		
Magic Joint Y 6	4 - 50	4 - 50	4 - 10	4 - 10	2,5 - 6	2,5 - 6	2,5 - 6	2,5 - 6	180 x 90	
Magic Joint Y25	50 - 150	50 - 150	10 - 25	10 - 25	6 - 25	6 - 16	6 - 25	6 - 10	220 x 105	
Magic Joint Y95	120 - 400	95 - 240	25 - 95	16 - 50	25 - 95	16 - 50	25 - 95	10 - 50	315 x 115	
Magic Joint Y240*	240 - 630	240 - 630	95 - 240	50 - 240	95 - 240	50 - 240	95 - 240	50 - 240	600 x 285	

T: Through - B: Branch  
\* also for aluminium cables.





## Magic Joint System Plus L

Straight joint + Five-core spacer.

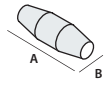

Product	Cable formation and conductor cross sections (n° x mm <sup>2</sup> )				Dimensions A x B (mm)
	2x	3x	4x	5x	
Magic Joint SP L6	1,5 - 6	1,5 - 6	1,5 - 6	1,5 - 6	180 x 50
Magic Joint SP L16	4 - 16	4 - 16	4 - 16	4 - 16	215 x 55
Magic Joint SP L25	4 - 25	4 - 25	4 - 25	4 - 25	215 x 65



## Magic Joint System Plus Y

Y branch joint with cast gel

Five-core spacer + screw connectors.

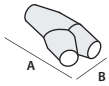

Product	Cable formation and conductor cross sections (n° x mm <sup>2</sup> )								Dimensions A x B (mm)
	2x		3x		4x		5x		
	T	B	T	B	T	B	T	B	
Magic Joint SP Y6	1,5 - 6	1,5 - 4	1,5 - 6	1,5 - 4	1,5 - 6	1,5 - 4	1,5 - 6	1,5 - 4	180 x 90
Magic Joint SP Y16	4 - 16	1,5 - 4	4 - 16	1,5 - 4	4 - 16	1,5 - 4	4 - 16	1,5 - 4	220 x 105

T: Through - B: Branch



## Magic Joint System Plus T

T Branch joint + Four-core spacer.

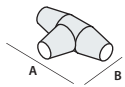

Product	Cable formation and conductor cross sections (n° x mm <sup>2</sup> )						Dimensions A x B (mm)
	2x		3x		4x		
	T	B	T	B	T	B	
Magic Joint SP T35	6 - 35	1,5 - 10	6 - 35	1,5 - 10	6 - 35	1,5 - 10	305 x 155

T: Through - B: Branch



## Magic Joint System Fast RP

Straight joint + Shear bolt connectors.

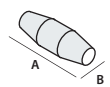

Product	Cable formation from 2x a 4x (n° x mm <sup>2</sup> )	Dimensions A x B (mm)
Magic Joint 35- RP/16	1,5 - 16	232 x 70
Magic Joint 35- RP/35	10 - 35	232 x 70
Magic Joint 50- RP/50	25 - 50	266 x 72
Magic Joint 120- RP/120	35 - 120	365 x 95
Magic Joint 240- RP/150	35 - 150	510 x 120



# Magic Joint Fire

Straight or branch joint with quick cross linking bi-component cast gel for 0.6/1 kV flame retardant cables.

Magic line joints are now also available in the flame retardant version, MAGIC JOINT-FIRE, particularly suitable for installations in places most at risk of fire: available in straight and branch types, they maintain the electrical and sealing characteristics of the traditional Magic line described above, but add a self-extinguishing property, together with their low smoke and toxic gas development and absence of halogen, as required by main international legislation.

- Flame retardant
- Quick cross linking gel
- Extremely adherent and tight sealing
- For 0.6/1 kV extruded cables
- Non-toxic and safe
- No shelf life



## Installation sequence



### Electrical performance:

CEI EN 50393 with connectors complying with EN 61238-1 (with testing under water head and water between the cable cores)  
Class 2 in accordance with CEI 64-8.

### No flame propagation:

CEI 20-35 • IEC 60332-1 HD405-1 (as applicable)  
Low smoke and toxic and corrosive gas emissions

Gel: UL 94-HB 

Casing mix: UL 94-V2

Degree of protection: IP68

 Operating temperature

 Installation temperature: -10°C / +55°C





## Magic Joint Fire

Straight joint for 0.6/1 kV extruded cables.

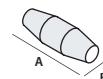

Product	Cable formation and conductor cross sections (n° x mm <sup>2</sup> )				Dimensions A x B (mm)
	1x	2x	3x	4x	
Magic Joint 4-Fire	1,5 - 25	1,5 - 4	1,5 - 4	1,5 - 4	160 x 45
Magic Joint 10-Fire	2,5 - 50	1,5 - 10	1,5 - 10	1,5 - 10 *	180 x 50
Magic Joint 25-Fire	16 - 150	4 - 25	4 - 25	2,5 - 25	215 x 55
Magic Joint 35-Fire	16 - 185	16 - 35	16 - 35	16 - 35	232 x 70
Magic Joint 50-Fire	50 - 300	16 - 50	16 - 50	16 - 50	266 x 72
Magic Joint 95-Fire	120 - 400	25 - 95	25 - 95	25 - 95	330 x 75
Magic Joint 120-Fire	240 - 500	70 - 120	70 - 120	50 - 120	365 x 95
Magic Joint 240-Fire	400 - 1000	120 - 300	120 - 240	120 - 240	510 x 120
Magic Joint 300-Fire	630 - 2000	240 - 400	240 - 300	240 - 300	760 x 180

Product	Cable formation and conductor cross sections (n° x mm <sup>2</sup> )				Dimensions A x B (mm)
	1x	2x	3x	4x	
Magic Joint 50-Fire	16 - 150	16 - 25	16 - 25	16 - 25	266 x 72
Magic Joint 120-Fire	185 - 400	25 - 95	25 - 95	25 - 95	365 x 95
Magic Joint 240-Fire	400 - 630	95 - 185	95 - 185	95 - 185	510 x 120
Magic Joint 300-Fire	630 - 2000	185 - 300	185 - 300	185 - 300	760 x 180



## Magic Joint Y Fire

Branch joint for 0.6/1 kV extruded cables.

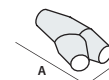

Product	Cable formation and conductor cross sections (n° x mm <sup>2</sup> )								Dimensions A x B (mm)
	1x		2x		3x		4x		
	T	B	T	B	T	B	T	B	
Magic Joint Y 6-Fire	4 - 50	4 - 50	4 - 10	4 - 10	2,5 - 6	2,5 - 6	2,5 - 6	2,5 - 6	180 x 90
Magic Joint Y25-Fire	50 - 150	50 - 150	10 - 25	10 - 25	6 - 25	6 - 16	6 - 25	6 - 10	220 x 105
Magic Joint Y95-Fire	120 - 400	95 - 240	25 - 95	16 - 50	25 - 95	16 - 50	25 - 95	10 - 50	315 x 115

T : Through - B : Branch



## Magic Joint S Fire

Straight joint for signalling and control.

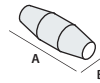

Product	Conductor cross sections (mm <sup>2</sup> )	Cable formation (n° conductors)											Dimensions A x B (mm)				
		5x	7x	10x	12x	16x	19x	24x	40x	75x	100x	250x		500x			
Magic Joint S11 Fire	1,5 2,5	•	•	•	•	•											180 x 50
Magic Joint S12 Fire	1,5 2,5			•	•	•	•	•									215 x 55
Magic Joint S13 Fire	1,5 2,5						•	•	•	•							266 x 72
Magic Joint S14 Fire	1,5 2,5								•	•	•						330 x 75
Magic Joint S15 Fire	1,5 2,5									•	•	•					365 x 95
Magic Joint S16 Fire	1,5 2,5										•	•	•				510 x 120
Magic Joint S17 Fire	1,5 2,5											•	•	•			760 x 180



## Magic Joint SY Fire

Branch joint for signalling and control.

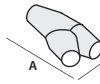

Product	Conductor cross sections (mm <sup>2</sup> )	Cable formation (n° conductors)									Dimensions A x B (mm)						
		5x	7x	10x	12x	16x	19x	24x	40x	75x							
Magic Joint SY1 Fire	1,5 2,5	•	•	•	•	•	•										180 x 90
Magic Joint SY2 Fire	1,5 2,5				•	•	•	•									220 x 105
Magic Joint SY3 Fire	1,5 2,5								•	•	•	•					315 x 115



## Magic Joint T Fire

Straight joint for telephone cable.

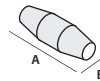

UNSCREENED	SCREENED	N° pairs per conductor cross sections (n° x mm <sup>2</sup> )	Dimensions A x B (mm)
Product	Product		
Magic Joint T16-Fire	Magic Joint TS16-Fire	1 - 16 x 0,5 - 0,6	180 x 50
Magic Joint T25-Fire	Magic Joint TS25-Fire	16 - 25 x 0,5 - 0,6	215 x 55
Magic Joint T35-Fire	Magic Joint TS35-Fire	25 - 35 x 0,5 - 0,6	266 x 72
Magic Joint T40-Fire	Magic Joint TS40-Fire	35 - 40 x 0,5 - 0,6	330 x 75
Magic Joint T64-Fire	Magic Joint TS64-Fire	40 - 64 x 0,5 - 0,6	365 x 95
Magic Joint T500-Fire	Magic Joint TS500-Fire	60 - 500 x 0,5 - 0,6	510 x 120
Magic Joint T1000-Fire	Magic Joint TS1000-Fire	450 - 1000 x 0,5 - 0,6	760 x 180





# Rubber Joint

Straight or branch joint with bicomponent cast quick cross linking rubber insulation for 0.6/1 kW cables.

**Electrical performance:**  
CEI EN 50393 with connectors complying with EN 61238-1 (with testing under water head and water between the cable cores) Class 2 in accordance with CEI 64-8.

**Degree of protection:** IP68

Operating temperature  90°

Installation temperature:  -15°C / +55°C

With new Magic Rubber insulation, designed and developed by Raytech for 0.6/1 kV cables. A new line of accessories with extremely high mechanical characteristics, as well as dielectric and thermal properties. The new line is re-enterable even after long periods of operation, is free of exotherm during cross linking, is extremely fast-acting and has no shelf life. Significant also for its very low emission of toxic and corrosive gases and fumes. Thanks to its exceptional mechanical characteristics, these joints are especially suitable for placement in traps or channels where there is the possibility of handling even after the laying of cables or, however, in cases of heavy abrasion, or mechanical stress within the normal parameters of installation and operation.

- Quick cross linking rubber (only 15 minutes)
- Very high mechanical and elastic characteristics
- For 0.6/1 kV extruded cables
- No shelf life



Installation sequence





# Rubber Joint

Straight joint for 0.6/1 kV extruded cables.

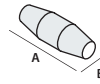

Product	Cable formation and conductor cross sections (n° x mm <sup>2</sup> )				Dimensions A x B (mm)
	1x	2x	3x	4x	
Rubber Joint 4	1,5 - 25	1,5 - 4	1,5 - 4	1,5 - 4	160 x 45
Rubber Joint 10	2,5 - 50	1,5 - 10	1,5 - 10	1,5 - 10 *	180 x 50
Rubber Joint 25	16 - 150	4 - 25	4 - 25	2,5 - 25	215 x 55
Rubber Joint 35	16 - 185	16 - 35	16 - 35	16 - 35	232 x 70
Rubber Joint 50	50 - 300	16 - 50	16 - 50	16 - 50	266 x 72
Rubber Joint 95	120 - 400	25 - 95	25 - 95	25 - 95	330 x 75
Rubber Joint 120	240 - 500	70 - 120	70 - 120	50 - 120	365 x 95
Rubber Joint 240	400 - 1000	120 - 300	120 - 240	120 - 240	510 x 120
Rubber Joint 300	630 - 2000	240 - 400	240 - 300	240 - 300	760 x 180

\* Rubber Joint 10 suggerito per diametri di cavo non superiori a 16 mm.



# Rubber Joint Y

Branch joint for 0.6/1 kV extruded cables.

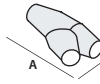

Product	Cable formation and conductor cross sections (n° x mm <sup>2</sup> )								Dimensions A x B (mm)
	1x		2x		3x		4x		
	T	B	T	B	T	B	T	B	
Rubber Joint Y6	4 - 50	4 - 50	4 - 10	4 - 10	2,5 - 6	2,5 - 6	2,5 - 6	2,5 - 6	180 x 90
Rubber Joint Y25	50 - 150	50 - 150	10 - 25	10 - 25	6 - 25	6 - 16	6 - 25	6 - 10	220 x 105
Rubber Joint Y95	120 - 400	95 - 240	25 - 95	16 - 50	25 - 95	16 - 50	25 - 95	10 - 50	315 x 115
Rubber Joint Y240*	240 - 630	240 - 630	95 - 240	95 - 240	95 - 240	95 - 240	95 - 240	50 - 240	600 x 285

T : Through - B : Branch  
\* also for aluminium cables.





# Raycast

Straight or branch joint with bicomponent epoxy resin insulation for 0.6/1 kV cables.

Straight or branch joints for 0.6/1 kV extruded cables: easily installed, composed of two anti-fracture plastic shells, to be filled with bicomponent epoxy resin such as Rayresin. For installation in traps, channels or directly underground.

**Electrical performance:**  
CEI EN 50393 with connectors complying with EN 61238-1 (with testing under water head and water between the cable cores)  
Class 2 in accordance with CEI 64-8.

Operating temperature **90°**

Installation temperature: **0°C / +45°C**



# Raycast L

Straight joint.

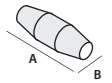

Product	Cable formation and conductor cross sections (n° x mm <sup>2</sup> )				Dimensions A x B (mm)
	1x	2x	3x	4x	
Raycast L10	2,5 - 50	1,5 - 10	1,5 - 10	1,5 - 10 *	180 x 50
Raycast L16/25	16 - 150	4 - 25	4 - 25	2,5 - 25	215 x 55
Raycast L35	16 - 185	16 - 35	16 - 35	16 - 35	232 x 70
Raycast L50	50 - 300	16 - 50	16 - 50	16 - 50	266 x 72
Raycast L95	120 - 400	25 - 95	25 - 95	25 - 95	330 x 75
Raycast L120	240 - 500	70 - 120	70 - 120	50 - 120	365 x 95
Raycast L240	400 - 1000	120 - 300	120 - 240	120 - 240	510 x 120

Product	Cable formation and conductor cross sections (n° x mm <sup>2</sup> )				(mm)
	1x	2x	3x	4x	
Raycast L50	16 - 150	16 - 25	16 - 25	16 - 25	266 x 72
Raycast L120	185 - 400	25 - 95	25 - 95	25 - 95	365 x 95
Raycast L240	400 - 630	95 - 185	95 - 185	95 - 185	510 x 120

\* Raycast L10 is suggested for cable diameters not exceeding 16 mm.



# Raycast D

Branch joint.

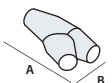

Product	Cable formation and conductor cross sections (n° x mm <sup>2</sup> )								Dimensions A x B (mm)
	1x		2x		3x		4x		
	T	B	T	B	T	B	T	B	
Raycast D6	4 - 50	4 - 50	4 - 10	4 - 10	2,5 - 6	2,5 - 6	2,5 - 6	2,5 - 6	180 x 90
Raycast D16/D25	50 - 150	50 - 150	10 - 25	10 - 25	6 - 25	6 - 16	6 - 25	6 - 10	220 x 105
Raycast D95	120 - 400	95 - 240	25 - 95	16 - 50	25 - 95	16 - 50	25 - 95	10 - 50	315 x 115

T: Through - B: Branch



## Raycast L-S / Raycast D-S

Joint screened.

Product	Cable formation and conductor cross sections (n° x mm <sup>2</sup> )				Dimensions A x B (mm)
	1x	2x	3x	4x	
Raycast L10-S	2,5 - 50	1,5 - 10	1,5 - 6	1,5 - 6	180 x 50
Raycast L25-S	16 - 120	4 - 25	4 - 16	2,5 - 16	215 x 55
Raycast L35-S	16 - 185	16 - 35	16 - 25	16 - 25	232 x 70
Raycast L50-S	50 - 240	16 - 50	16 - 50	16 - 50	266 x 72
Raycast L120-S	240 - 500	70 - 120	70 - 120	50 - 95	365 x 95
Raycast L240-S	400 - 1000	120 - 300	120 - 185	120 - 185	510 x 120

For ALUMINIUM cables					
Product	1x	2x	3x	4x	Dimensions A x B (mm)
Raycast L50-S	16 - 150	16 - 25	16 - 25	16 - 25	266 x 72
Raycast L120-S	185 - 400	25 - 95	25 - 95	25 - 95	365 x 95
Raycast L240-S	400 - 630	95 - 185	95 - 185	95 - 185	510 x 120

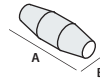

Product	Cable formation and conductor cross sections (n° x mm <sup>2</sup> )								Dimensions A x B (mm)
	1x		2x		3x		4x		
	T	B	T	B	T	B	T	B	
Raycast D6-S	4 - 35	4 - 35	4 - 10	4 - 10	2,5 - 6	1,5 - 6	2,5 - 6	2,5 - 6	180 x 90
Raycast D25-S	35 - 120	35 - 120	10 - 25	10 - 25	6 - 16	6 - 16	6 - 16	6 - 10	220 x 105
Raycast D95-S	95 - 300	70 - 150	25 - 95	16 - 50	16 - 70	16 - 35	16 - 50	10 - 35	315 x 115

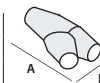

T: Through - B: Branch

## Raycast L-ARM / D-ARM

Joint for tape, wire or plate armoured cables.

Product	Cable formation and conductor cross sections (n° x mm <sup>2</sup> )				Dimensions A x B (mm)
	2x		3x		
Raycast L10-ARM	1,5 - 10	1,5 - 10	1,5 - 6	1,5 - 6	180 x 50
Raycast L25-ARM	4 - 25	4 - 25	4 - 16	2,5 - 16	215 x 55
Raycast L35-ARM	16 - 35	16 - 35	16 - 25	16 - 25	232 x 70
Raycast L50-ARM	16 - 50	16 - 50	16 - 50	16 - 50	266 x 72
Raycast L120-ARM	70 - 120	70 - 120	70 - 120	50 - 95	365 x 95
Raycast L240-ARM	120 - 300	120 - 300	120 - 185	120 - 185	510 x 120

For ALUMINIUM cables				
Product	2x	3x	4x	(mm)
Raycast L50-ARM	16 - 25	16 - 25	16 - 25	266 x 72
Raycast L120-ARM	25 - 95	25 - 95	25 - 95	365 x 95
Raycast L240-ARM	95 - 185	95 - 185	95 - 185	510 x 120

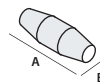

Product	Cable formation and conductor cross sections (n° x mm <sup>2</sup> )								Dimensions A x B (mm)
	2x		3x		4x				
	T	B	T	B	T	B	T	B	
Raycast D6-ARM-F	4 - 10	4 - 10	2,5 - 6	2,5 - 6	2,5 - 6	2,5 - 6	2,5 - 6	2,5 - 6	180 x 90
Raycast D16-ARM-F	10 - 25	10 - 25	6 - 16	6 - 16	6 - 16	6 - 16	6 - 16	6 - 10	220 x 105
Raycast D95-ARM-F	25 - 70	16 - 50	25 - 70	16 - 35	25 - 50	10 - 35	25 - 50	10 - 35	315 x 115

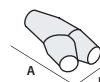

For TAPE OR PLATE armoured

Raycast D6-ARM	4 - 10	4 - 10	2,5 - 6	2,5 - 6	2,5 - 6	2,5 - 6	180 x 90
Raycast D16-ARM	10 - 25	10 - 25	6 - 16	6 - 16	6 - 16	6 - 10	220 x 105
Raycast D95-ARM	25 - 70	16 - 50	25 - 70	16 - 35	25 - 50	10 - 35	315 x 115

T: Through - B: Branch



## Raycast LPS / DPS

Joint for very deep submersible pumps.

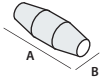

Product	Cable formation and conductor cross sections (n° x mm <sup>2</sup> )				A x B (mm)
	1x	2x	3x	4x	
Raycast LPS10	2,5 - 50	1,5 - 10	1,5 - 10	1,5 - 10	180 x 50
Raycast LPS25	16 - 150	4 - 25	4 - 25	2,5 - 25	215 x 55
Raycast LPS95	120 - 400	25 - 95	25 - 95	25 - 95	330 x 75
Raycast LPS240	400 - 1000	120 - 300	120 - 240	120 - 240	510 x 120

Product	Cable formation and conductor cross sections (n° x mm <sup>2</sup> )								A x B (mm)
	1x		2x		3x		4x		
	T	B	T	B	T	B	T	B	
Raycast DPS6	4-50	4-50	4-10	4-10	2,5-6	2,5-6	2,5-6	2,5-6	180 x 90
Raycast DPS25	50-150	50-150	10-25	10-25	6-25	6-16	6-16	6-10	220 x 105
Raycast DPS95	120-400	95-240	25-95	16-50	25-95	16-50	25-95	10-50	315 x 115

T: Through - B: Branch



## Raycast SL /SD

Joint for signalling and control.

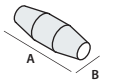

Product	Conductor cross sections (mm <sup>2</sup> )	Cable formation (n° conductors)										Dimensions A x B (mm)			
		5x	7x	10x	12x	16x	19x	24x	40x	75x	100x		250x		
Raycast SL11	1,5 2,5	•	•	•	•	•									180 x 50
Raycast SL12	1,5 2,5			•	•	•	•	•							215 x 55
Raycast SL13	1,5 2,5					•	•	•	•						266 x 72
Raycast SL14	1,5 2,5							•	•	•					330 x 75
Raycast SL15	1,5 2,5								•	•	•				365 x 95
Raycast SL16	1,5 2,5									•	•	•			510 x 120

Product	(mm <sup>2</sup> )	5x	7x	10x	12x	16x	19x	24x	40x	75x	Dimensions A x B (mm)
Raycast SD1	1,5 2,5	•	•	•	•	•	•				180 x 90
Raycast SD2	1,5 2,5			•	•	•	•	•			220 x 105
Raycast SD3	1,5 2,5							•	•	•	315 x 115



## Raycast TL and TSL

Straight joint for telephone cable.

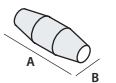

UNscreened Product	SCREENED Product	N° pairs per conductor cross sections (n° x mm <sup>2</sup> )	Dimensions A x B (mm)
Raycast TL16	Raycast TSL16	1 - 16 x 0,5 - 0,6	180 x 50
Raycast TL25	Raycast TSL25	16 - 25 x 0,5 - 0,6	215 x 55
Raycast TL35	Raycast TSL35	25 - 35 x 0,5 - 0,6	266 x 72
Raycast TL40	Raycast TSL40	35 - 40 x 0,5 - 0,6	330 x 75
Raycast TL64	Raycast TSL64	40 - 64 x 0,5 - 0,6	365 x 95
Raycast TL500	Raycast TSL500	60 - 500 x 0,5 - 0,6	510 x 120



## Raycast System Plus L

Straight joint + Five-core spacer.

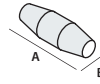

For <b>COPPER</b> cables		Cable formation and conductor cross sections (n° x mm <sup>2</sup> )				Dimensions A x B (mm)
Product		2x	3x	4x	5x	
Raycast SP L6		1,5 - 6	1,5 - 6	1,5 - 6	1,5 - 6	180 x 50
Raycast SP L16		4 - 16	4 - 16	4 - 16	4 - 16	215 x 55
Raycast SP L25		4 - 25	4 - 25	4 - 25	4 - 25	215 x 65



## Raycast System Plus Y

Y Branch joint + Five-core spacer.

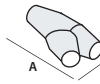

For <b>COPPER</b> cables		Cable formation and conductor cross sections (n° x mm <sup>2</sup> )								Dimensions A x B (mm)
Product		2x		3x		4x		5x		
		T	B	T	B	T	B	T	B	
Raycast SP D6		1,5 - 6	1,5 - 4	1,5 - 6	1,5 - 4	1,5 - 6	1,5 - 4	1,5 - 6	1,5 - 4	180 x 90
Raycast SP D16		4 - 16	1,5 - 4	4 - 16	1,5 - 4	4 - 16	1,5 - 4	4 - 16	1,5 - 4	220 x 105

T: Through - B: Branch



## Raycast System Plus T

T Branch joint + Four-core spacer.

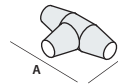

For <b>COPPER</b> cables		Cable formation and conductor cross sections (n° x mm <sup>2</sup> )						Dimensions A x B (mm)
Product		2x		3x		4x		
		T	B	T	B	T	B	
Raycast SP T 35		6 - 35	1,5 - 10	6 - 35	1,5 - 10	6 - 35	1,5 - 10	305 x 155

T: Through - B: Branch



## Raycast System Fast RP

Straight joint + Shear bolt connectors.

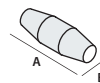

Product	Cable formation from 2x a 4x (n° x mm <sup>2</sup> )	Dimensions A x B (mm)
Raycast L 35- RP/16	1,5 - 16	232 x 70
Raycast L 35- RP/35	10 - 35	232 x 70
Raycast L 50- RP/50	25 - 50	266 x 72
Raycast L 120- RP/120	35 - 120	365 x 95
Raycast L 240- RP/150	35 - 150	510 x 120



Ray  
tech





LV



# Wonder Joint

Straight or branch injectable joint using Wonder Fluid, single component insulating gel. Quick to use and can be installed at any temperature.

Joint equipped with injection valve; insert the cartridge in the gun, connect the nozzle stably on the valve and inject the gel until completely filled. The valve on the container prevents insulation from leaking out, ensuring perfect cleaning and reliability. Can be installed without any special tools: only requires a regular silicone gun.

- Joints insulated with **Wonder Fluid**, fluid, single-component, gel
- Clean installation, re-enterable and inspectable
- Container provided with no-return valve
- Immediately energizable
- Even suitable for high depths
- Non-toxic, with no expiry date



**Electrical performance:**  
 CEI EN 50393 with connectors  
 complying with EN 61238-1  
 (with testing under water head  
 and water between the cable cores)  
 Class 2 in accordance with CEI 64-8.

**Gel:** UL 94-HB

**Degree of protection:** IP68

Operating temperature **90°**

Installation temperature: **-50°C / +60°C**

## Installation sequence



**Ray  
Tech**

## Wonder Joint L

Straight joint with injected gel insulation.

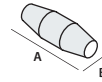

For <b>COPPER</b> cables	Cable formation and conductor cross sections (n° x mm <sup>2</sup> )				A x B (mm)
Product	1x	2x	3x	4x	
Wonder Joint L4	1,5 - 25	1,5 - 4	1,5 - 4	1,5 - 4	160 x 45
Wonder Joint L10	2,5 - 50	1,5 - 10	1,5 - 10	1,5 - 10	180 x 50
Wonder Joint L25	16 - 150	4 - 25	4 - 25	2,5 - 25	215 x 55



## Wonder Joint System Plus L

Straight joint with injected gel insulation + Five-core spacer.

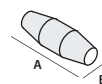

For <b>COPPER</b> cables	Cable formation and conductor cross sections (n° x mm <sup>2</sup> )				A x B (mm)
Product	2x	3x	4x	5x	
Wonder Joint SP L6	1,5 - 6	1,5 - 6	1,5 - 6	1,5 - 6	180 x 50
Wonder Joint SP L25	4 - 25	4 - 25	4 - 25	4 - 25	215 x 55



## Wonder Joint Y

Branch joint with injected gel insulation.

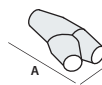

For <b>COPPER</b> cables	Cable formation and conductor cross sections (n° x mm <sup>2</sup> )								A x B (mm)
	1x		2x		3x		4x		
Product	P	D	P	D	P	D	P	D	
Wonder Joint Y6	4 - 50	4 - 50	4 - 10	4 - 10	2,5 - 6	2,5 - 6	2,5 - 6	2,5 - 6	180 x 90
Wonder Joint Y25	50 - 150	50 - 150	10 - 25	10 - 25	6 - 25	6 - 16	6 - 25	6 - 10	220 x 105

T: Through - B: Branch



## Wonder Joint System Plus Y

Branch joint with injected gel insulation + Five-core spacer.

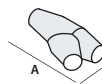

For <b>COPPER</b> cables	Cable formation and conductor cross sections (n° x mm <sup>2</sup> )								A x B (mm)
	2x		3x		4x		5x		
Product	T	B	T	B	T	B	T	B	
Wonder Joint SP Y6	1,5 - 6	1,5 - 4	1,5 - 6	1,5 - 4	1,5 - 6	1,5 - 4	1,5 - 6	1,5 - 4	180 x 90
Wonder Joint SP Y16	4 - 16	1,5 - 4	4 - 16	1,5 - 4	4 - 16	1,5 - 4	4 - 16	1,5 - 4	220 x 105

T: Through - B: Branch





**Electrical performance:**  
CEI EN 50393 with connectors  
complying with EN 61238-1  
(with testing under water head  
and water between the cable cores)  
Class 2 in accordance with CEI 64-8.

**No flame propagation:**  
CEI 20-35 • IEC 60332-1 HD405-1  
(as applicable)

Operating temperature  90°

Installation temperature:  -15°C / +45°C

# Heat-shrink

Straight or branch heat-shrinkable joints  
for extruded insulation cables up to a 1 kV.

## Installation sequence

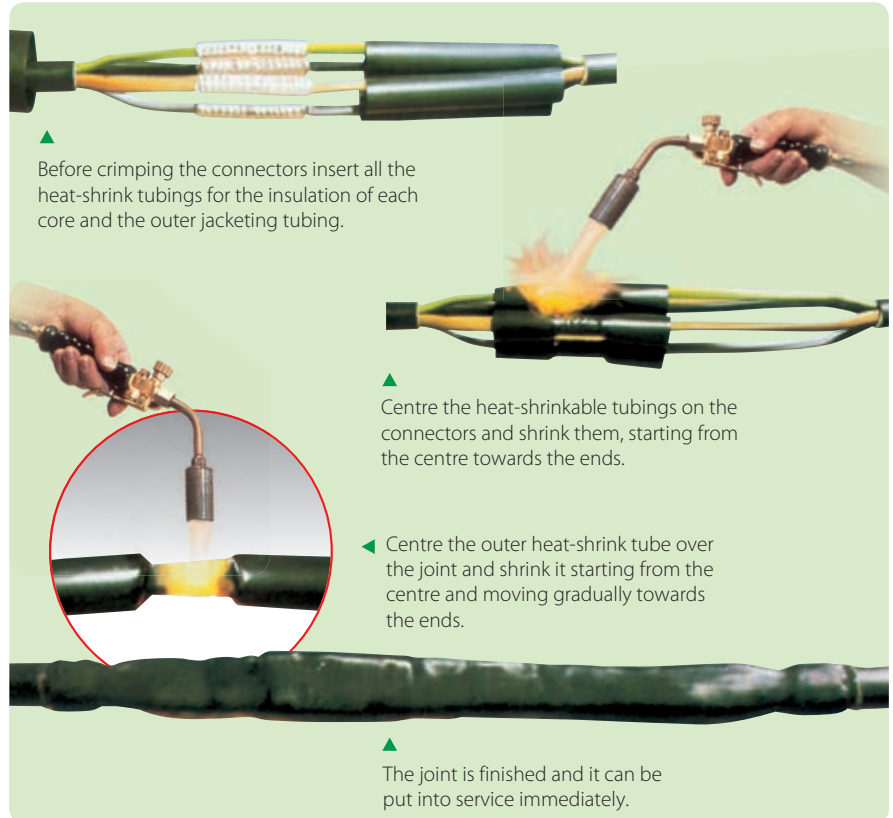



## GDL

Joint for single core cables including concentric neutral.

Product	Conductor cross section mm <sup>2</sup>		Dimensions L (mm)
	from	to	
GDL 92 A1	4	10	300
GDL 92 A2	16	150	300
GDL 92 A3	185	400	300
GDL 92 PA	10	50	300

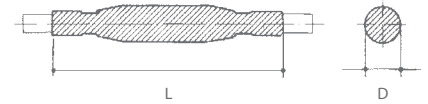

## GLV

Joint for multi core cables (also for submersible pumps).

Product	Conductor cross section mm <sup>2</sup>		Number of phases	Dimensions L (mm) D (mm)	
	from	to		L (mm)	D (mm)
GLV 0306	1,5	6	3	250	18
GLV 0316	10	16	3	400	37
GLV 0335	25	35	3	550	43
GLV 0370	50	70	3	650	52
GLV 3150	95	150	3	800	65
GLV 3300	185	300	3	900	82
GLV 0406	1,5	6	4	250	20
GLV 0416	10	16	4	400	40
GLV 0435	25	35	4	650	45
GLV 0470	50	70	4	650	54
GLV 4150	95	150	4	800	67
GLV 4300	185	300	4	900	84
GLV 2,5 - CP	2,5 complete with connectors		4	300	15

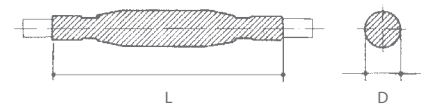

For both copper and aluminium cables. For aerial, underground, submerged installation.

## GLV-N

Joint for multi core cables with concentric neutral.

Product	Conductor cross section mm <sup>2</sup>		Number of phases	Dimensions L (mm) D (mm)	
	from	to		L (mm)	D (mm)
GLV 0306 - N	1,5	6	3	250	18
GLV 0316 - N	10	16	3	400	37
GLV 0335 - N	25	35	3	550	43
GLV 0370 - N	50	70	3	650	52
GLV 3150 - N	95	150	3	800	65
GLV 3300 - N	185	300	3	900	82
GLV 0406 - N	1,5	6	4	250	20
GLV 0416 - N	10	16	4	400	40
GLV 0435 - N	25	35	4	650	45
GLV 0470 - N	50	70	4	650	54
GLV 4150 - N	95	150	4	800	67
GLV 4300 - N	185	300	4	900	84

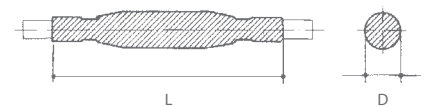

These kits include components for the phase insulation, metallic braiding to replace the neutral and external self-sealing heat-shrinkable tube.

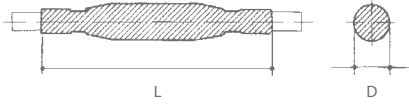

## GLV-ARM

Joint for armoured multi core cables.

Product	Conductor cross section (mm <sup>2</sup> )		Dimensions	
	from	to	L (mm)	D (mm)
GLV 0406-ARM	1,5	6	300	25
GLV 0416-ARM	6	16	400	40
GLV 0450-ARM	25	50	800	60
GLV 4150-ARM	70	150	1000	100
GLV 4300-ARM	185	300	1000	120

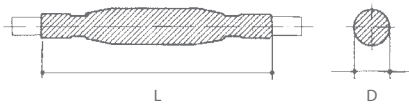

## BOPA

Joint for MV cables for public lighting.

Product	Operating voltage kV	Number of phases	Section (mm <sup>2</sup> )	Dimensions	
				L (mm)	D (mm)
BOPA 3	3	1	1x10	300	50
BOPA 4	3	2	2x10	450	60
BOPA 5	3	3	3x10	450	70
BOPA 3/2	3,6	1 + concentric neutral	1 x 6 + 6 concentric	700	35
BOPA 4/T transition	3	2	2,5 - 10 paper / 10 - 50 extruded	750	40

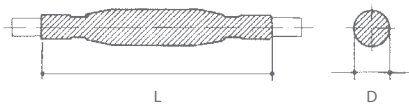

## DJ

LV branch joint.

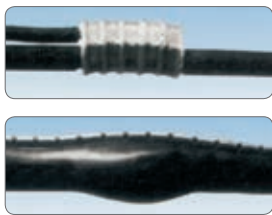

Product	Single core cables cross section (mm <sup>2</sup> )		Multi core cables cross section (mm <sup>2</sup> )		Dimensions	
	Through	Branch	Through	Branch	L (mm)	D (mm)
DJ01	1 x 4 - 50	1 x 2,5 - 50	4 x 1,5 - 10	2 x 1,5	200	25
DJ02	1 x 50 - 120	1 x 6 - 120	4 x 16 - 25 2 single core cables	2x1,5 1 two core cable	250	40
DJ03	1 x 150 - 300	1 x 6 - 300	4 x 25 - 3,5 x 50	4 x 2,5 - 25	400	70

## GLV System Fast RP

Straight joint + Shear bolt connectors.

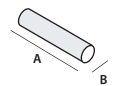

Product	Cable formation 4x (n° x mm <sup>2</sup> )	Dimensions A x B (mm)
GLV 0435- RP/16	6 - 16	650 x 50
GLV 0470- RP/35	25 - 35	650 x 70
GLV 0470- RP/50	25 - 50	650 x 75
GLV 4150- RP/150	50 - 150	800 x 80

## GLV F/R - GMP F/R

Joint for fire resistant cables (0,6/1 kV).

FOR NAVAL TYPE POWER CABLES

UNARMOURED			ARMOURED		
Product	Cable formation (n° x mm <sup>2</sup> )	L (mm)	Product	Cable formation (n° x mm <sup>2</sup> )	L (mm)
GLV 4004-F/R	4 x 1,5 - 4	300	GLV 4004-ARM-F/R	4 x 1,5 - 4	400
GLV 4016-F/R	4 x 6 - 16	300	GLV 4016-ARM-F/R	4 x 6 - 16	400
GLV 4050-F/R	4 x 25 - 50	400	GLV 4050-ARM-F/R	4 x 25 - 50	500
GLV 4150-F/R	4 x 70 - 150	500	GLV 4150-ARM-F/R	4 x 70 - 150	750

FOR NAVAL TYPE SIGNALLING AND CONTROL CABLES

UNARMOURED			ARMOURED		
Product	Cable formation (n° x mm <sup>2</sup> )	L (mm)	Product	Cable formation (n° x mm <sup>2</sup> )	L (mm)
GMP 007-F/R	4 - 7 x 1,5 - 2,5	300	GMP 007-ARM-F/R	4 - 7 x 1,5 - 2,5	400
GMP 014-F/R	10 - 14 x 1,5 - 2,5	300	GMP 014-ARM-F/R	10 - 14 x 1,5 - 2,5	400
GMP 030-F/R	16 - 30 x 1,5 - 2,5	400	GMP 030-ARM-F/R	16 - 30 x 1,5 - 2,5	500

FOR UNDERGROUND POWER CABLES

UNARMOURED			ARMOURED		
Product	Cable formation (n° x mm <sup>2</sup> )	L (mm)	Product	Cable formation (n° x mm <sup>2</sup> )	L (mm)
GLV 4006-F/R-G7	4 x 1,5 - 6	300	GLV 4006-ARM-F/R-G7	4 x 1,5 - 6	400
GLV 4016-F/R-G7	4 x 6 - 16	300	GLV 4016-ARM-F/R-G7	4 x 6 - 16	400
GLV 4050-F/R-G7	4 x 25 - 50	400	GLV 4050-ARM-F/R-G7	4 x 25 - 50	500
GLV 4150-F/R-G7	4 x 70 - 150	500	GLV 4150-ARM-F/R-G7	4 x 70 - 150	750

FOR UNDERGROUND SIGNALLING AND CONTROL CABLES

UNARMOURED			ARMOURED		
Product	Cable formation (n° x mm <sup>2</sup> )	L (mm)	Product	Cable formation (n° x mm <sup>2</sup> )	L (mm)
GMP 014-F/R-G7	Fino a 14 x 1,5 - 2,5	300	GMP 014-ARM-F/R-G7	Fino a 14 x 1,5 - 2,5	400
GMP 019-F/R-G7	Fino a 19 x 1,5 - 2,5	400	GMP 019-ARM-F/R-G7	Fino a 19 x 1,5 - 2,5	500

## DJ F/R

Branch joint for fire resistant cables (0,6/1 kV).

FOR POWER CABLES

UNARMOURED		ARMOURED		L (mm)
Product	Product	Cable formation (n° x mm <sup>2</sup> )		
DJ 4016 - F/R	DJ 4016 - ARM-F/R	Through	Branch	300
		3 - 4 x 1,5 - 16	3 - 4 x 1,5 - 16	

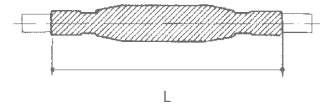

### Prestazioni elettriche:

CEI EN 50393 con connettori a norma EN 61238-1 (con prova sotto battente d'acqua e acqua tra le anime del cavo) in classe 2 secondo la norma CEI 64-8

### Resistenza alla fiamma:

IEC 60331-21 • CEI 20-36/2-1 (per quanto applicabili)

Per altre formazioni e sezioni di cavo contattare Raytech.

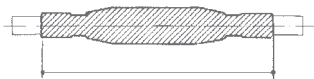

## GMP

Joint kits for multi conductor cables for signalling, command and control.

NON ARMoured cable		N° of conductors		Section mm <sup>2</sup>		External Ø of cable	
Product		from	to	from	to	min (mm)	max (mm)
GMP 007		4	7	1,0	2,5	8	19
GMP 014		8	14	1,0	2,5	12	22
GMP 021		15	21	1,0	2,5	15	27
GMP 040		22	40	1,0	2,5	20	35
GMP 075		41	75	1,0	2,5	26	44
GMP 100		76	100	1,0	2,5	26	60

ARMoured cable		N° of conductors		Section mm <sup>2</sup>		External Ø of cable	
Product		from	to	from	to	min (mm)	max (mm)
GMP 007-A		4	7	1,0	2,5	14	23
GMP 014-A		8	14	1,0	2,5	15	26
GMP 021-A		15	21	1,0	2,5	24	35
GMP 040-A		22	40	1,0	2,5	30	45
GMP 075-A		41	75	1,0	2,5	39	55

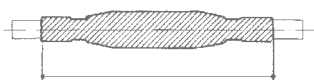

## GMC

Joint kits for multi pair cables for communication, command or control.

NON ARMoured cable		N° of pairs		Section mm <sup>2</sup>		External Ø of cable	
Product		from	to	from	to	min (mm)	max (mm)
GMC 010		5	10	2 x 0,6	2 x 1,0	9	14
GMC 020		11	20	2 x 0,6	2 x 1,0	13	20
GMC 030		21	30	2 x 0,6	2 x 1,0	16	24
GMC 050		31	50	2 x 0,6	2 x 1,0	22	29
GMC 100		51	100	2 x 0,6	2 x 1,0	30	40

ARMoured cable		N° of pairs		Section mm <sup>2</sup>		External Ø of cable	
Product		from	to	from	to	min (mm)	max (mm)
GMC 004-A		1	4	2 x 0,6	2 x 1,0	15	23
GMC 007-A		5	7	2 x 0,6	2 x 1,0	15	26
GMC 019-A		8	19	2 x 0,6	2 x 1,0	24	35
GMC 037-A		20	37	2 x 0,6	2 x 1,0	30	45
GMC 061-A		38	61	2 x 0,6	2 x 1,0	39	55



# Terminals heat-shrink

## TLV

Terminations for armoured and non armoured extruded cables up to 1 kV.

Product	Product	Section conductor mm <sup>2</sup>		Number of phases
		from	to	
TLV 0216	TLV 0216 - AF	4	16	2
TLV 0316	TLV 0316 - AF	4	16	3
TLV 0416	TLV 0416 - AF	4	16	4
TLV 0250	TLV 0250 - AF	25	50	2
TLV 0350	TLV 0350 - AF	25	50	3
TLV 0450	TLV 0450 - AF	25	50	4
TLV 3150	TLV 3150 - AF	70	150	3
TLV 4150	TLV 4150 - AF	70	150	4
TLV 3300	TLV 3300 - AF	185	300	3
TLV 4300	TLV 4300 - AF	185	300	4
	TLV 4500 - AF	500		4

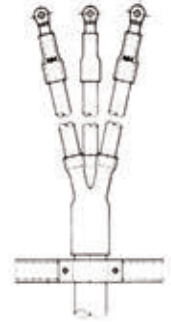

Include sheath to cover phases, sealing of the point of divergence of phases and sealing between phase and cable terminal.

## TLV 500

Terminations for concentric neutral extruded cables up to 1 kV.

Product	Section conductor mm <sup>2</sup>		Number of phases
	from	to	
TLV 0116 - 500	4	16	1
TLV 0216 - 500	4	16	2
TLV 0316 - 500	4	16	3
TLV 0150 - 500	25	50	1
TLV 0250 - 500	25	50	2
TLV 0350 - 500	25	50	3
TLV 2150 - 500	70	150	2
TLV 3150 - 500	70	150	3
TLV 2300 - 500	185	300	2
TLV 3300 - 500	185	300	3



Include sheath to cover the concentric conductor.



# FILLERS

Insulators and sealing for protecting electrical connections.



## Gel

BICOMPONENT CAST

page  
76



**Magic Power Gel**  
Self-amalgamating bicomponent gel in single bottles



**Magic Gel**  
Bicomponent gel in bottles



**Magic Fluid**  
Bicomponent gel in single dose bags



**Ray Gel**  
Bicomponent gel in bottles for telephone and intercom systems



**Bag Gel**  
Bicomponent gel in bags for telephone and intercom systems

## GelGum

BICOMPONENT CAST

page  
88



**TechnoGelGum**  
Bicomponent in single bottle



**GelGum Joint**  
Kit Techno Gel Gum + joints





# Gel

SINGLE COMPONENT INJECTABLE

page  
82



**Wonder Gel**  
Single coloured component



**Wonder Gel Invisible**  
Single transparent component



**Wonder Fluid**  
Single fluid component



**Monogel**  
Single coloured component

ITALIAN UTILITY MODEL



# Rubber

BICOMPONENT PASTE/CAST

page  
91



**Sky Plast**  
Mouldable bicomponent rubber



**Magic Rubber & Rubber Fluid**  
Bicomponent rubber in bottles or single dose bags

# Resin

BICOMPONENT CAST

page  
93



**Ray Resin**  
Bicomponent epoxy resin in single dose bags



# Magic Power Gel

Gel: UL 94-HB

**Dielectric strength:**  
>23 kV/mm

**Cross linking time:**  
fast (about 15 min. at 25°C)

**Volume resistivity:**  
>2 · 10<sup>15</sup> Ω cm

**Operating temperature:**  
-60°C / +200°C

**Overload temperature  
for short periods:**  
up to 250°C

**Stabilised for:**  
mould - UV

**Degree of protection:**  
IP68 (in proper casings)

**IP68**  
OFFICIALLY  
TESTED

**IMQ**

Nonfood  
Compounds  
P1

**NSF**

INSULATING and SEALING GEL

RE-ENTERABLE

RE-USABLE

The unique bi-component gel in a single bottle, with superior dielectric, sealing and thermal characteristics, re-enterable and re-usable!

- Very sticky
- Strong self amalgamating characteristics
- Single compact bottle; convenient twin compartment
- Re-usable as well as re-enterable, even after long working periods
- It doesn't give any waste
- The gel is not-classified as hazardous under the CLP Directive





### Stickiness

- Exceptional sealing properties in any condition
- Better resistance to pressure
- Effective even in vertical or ceiling applications

### Self-agglomerating

- Once cross linked it perfectly adheres on itself characteristics to get an homogeneous and compact mass
- It can be therefore applied in multiple layers

### Zero waste

- Due to the nature of the product waste is eliminated; even residual product can be saved and used for the next application
- Also any left over product maintains it's high performance characteristics

### Single bottle

- Highly useful
- The most compact packaging
- Less space occupied in the toolbox
- Both components in the same packaging



For all types of connections, even in the toughest conditions, for power, telecom and signalling!

Product	Colour	Package type	Quantity
Magic Power Gel	●	1 single, bi-component bottle 1 small basin - 1 mixing spoon	1000 ml
Magic Power Gel 500	●	1 single, bi-component bottle 1 small basin - 1 mixing spoon	500 ml
Magic Power Gel 250	●	1 single, bi-component bottle	250 ml
Magic Power Gel Bag 150	●	Bicomponent single dose bag	150 ml
Magic Power Gel Bag 250	●	Bicomponent single dose bag	250 ml

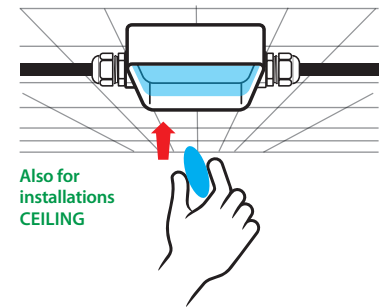
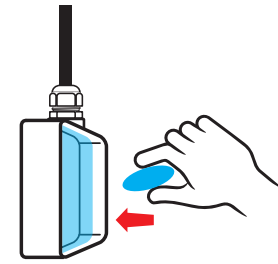
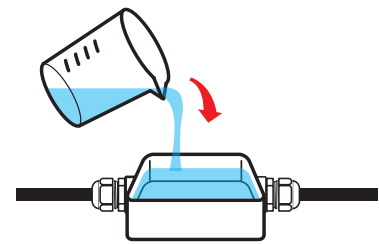

# Magic Gel & Magic Fluid

Bicomponent gel with very high dielectric and thermal characteristics, ideal for connection systems (joint shells or enclosures) for power cables.

The insulating and sealing gel, when cast in suitable casings, ensures an IP68 degree of protection and it is able to replace all types of resins. This is a self-polymer insulation in bottle or in a single use bag, with cold cross linking. Once poured, the insulation, characterized by very low viscosity, surrounds and envelopes any type of material, cross linking in less than 10 minutes. Cross linking with a very slow isothermal peak that does not thermally stress the materials it comes into contact with.

Gel: UL 94-HB 

**Dielectric strength:**

>23 kV/mm

**Cross linking time:**

fast (about 10 min. at 23°C)

**Volume resistivity:**

>2 . 10<sup>15</sup> Ω cm

**Working temperature:**

-60°C / +200°C

**Overload temperature**

**for short periods:**

up to 250°C

**Stabilised for:**

mould - UV

**Degree of protection:**

IP68 (in proper casings)

**IP68**  
OFFICIALLY  
TESTED | **IMQ**

Nonfood  
Compounds  
P1



- For high temperature applications!
- Quick cross linking (only 10 minutes)
- Re-enterable also after long working periods
- The gel is not-classified as hazardous under the CLP Directive
- Low viscosity



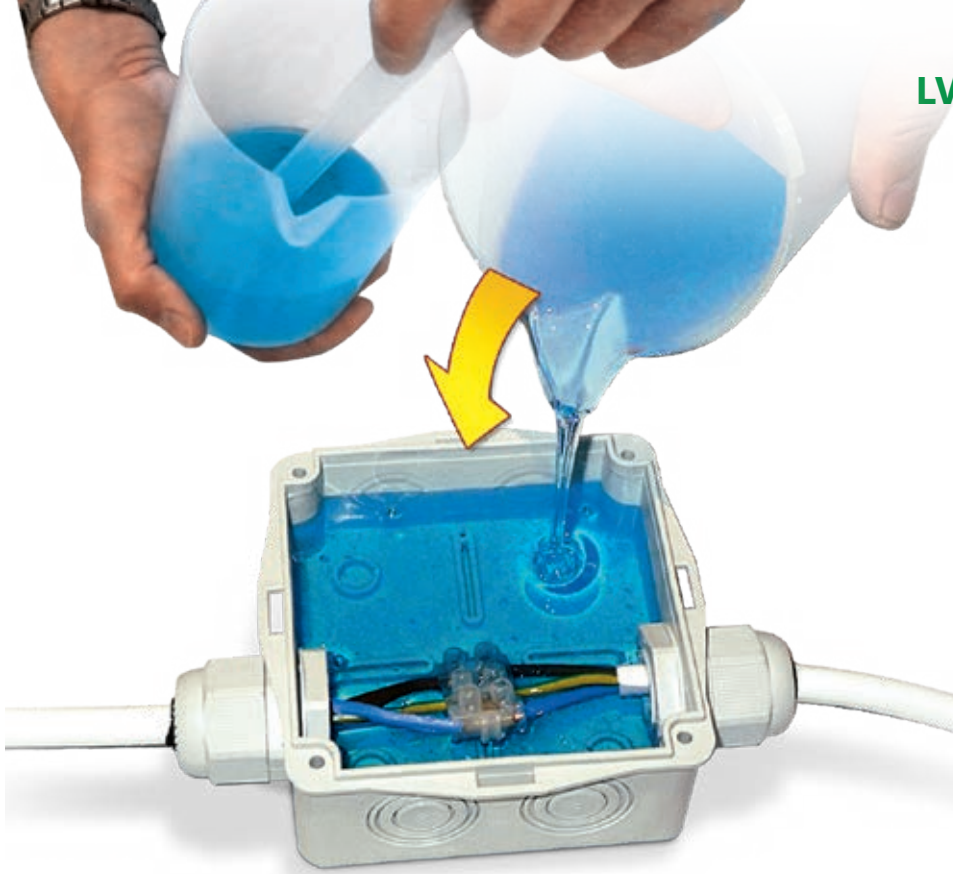

Product	Colour	Package type	Total quantity
Magic Gel 300	●	2 bottles	300 ml
Magic Gel 420	●	1 single, bi-component bottle 1 small basin - 1 mixing spoon	420 ml
Magic Gel 1000	●	2 bottles - 1 small basin - 1 mixing spoon	1000 ml
Magic Gel 2000	●	2 single, bi-component bottles 1 small basin - 1 mixing spoon	2 x 1000 ml
Magic Gel 10000	●	2 tanks - 1 small basin - 1 mixing spoon	10 lt

Magic Fluid 90	●	Bicomponent single dose bag	90 gr
Magic Fluid 110	●	Bicomponent single dose bag	110 gr
Magic Fluid 170	●	Bicomponent single dose bag	170 gr
Magic Fluid 210	●	Bicomponent single dose bag	210 gr
Magic Fluid 420	●	Bicomponent single dose bag	420 gr
Magic Fluid 550	●	Bicomponent single dose bag	550 gr



**Problem ENERGY**

What does a gel for this type of system have to give?

- ✓ **INSULATION:** Elevated voltages (1 kV operating, 4 kV testing)
- ✓ **THERMAL PERFORMANCE:** Operating temperature 90°C, overload temperature 130°C, short circuit temperature 250°C
- ✓ **SEALING:** Installations also possible in humid environments, flooded wells
- ✓ **DEGREE OF PROTECTION:** Must also work with water between the cores of the cable
- ✓ **CERTIFIED SYSTEMS:** The combination of insulation gel + casing must comply with current standards CEI 20-33 and EN 50393

**Solution:** *Magic Gel* meets all your Energy system requirements!

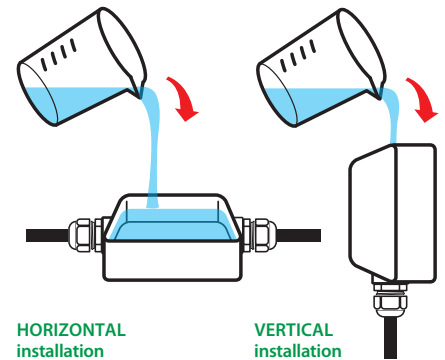

HORIZONTAL installation

VERTICAL installation



# Ray Gel

Insulating, sealing, re-enterable fast cross linking bicomponent silicone gel for telephone and intercom systems and for LED and display protection.

- Gel:** UL 94-HB 
- Dielectric strength:** >23 kV/mm
- Cross linking time:** fast (about 3 min. at 30°C)
- Volume resistivity:** >1,5 x 10<sup>15</sup> Ω cm
- Operating temperature:** -60°C / +180°C
- Thermal conductivity:** < 0,2 W/m<sup>2</sup>K
- Dielectric constant:** < 7
- Degree of protection:** IP68 (in proper casings)

- Quick cross linking
- Antioxidant protection
- Low temperature resistant
- Non-toxic and safe with no shelf life

**IP68**  
OFFICIALLY  
TESTED | **IMQ**





**RED**

- Specially formulated for UV resistance
- Suitable for "surface" installations
- Ideal for intercom systems



**TRANSPARENT**

- Excellent transparency
- Does not opacify
- Ideal for protecting printed circuit boards, for sealing displays, for insulating and sealing LEDs

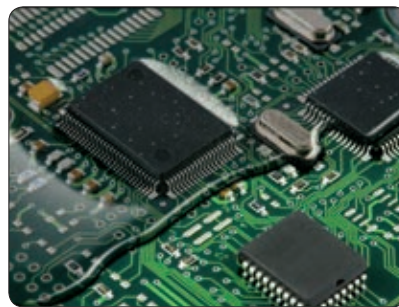

Ray Gel / Bag Gel

Product	Colour	Package type	Total quantity
Bag Gel 200-T	○	Bicomponent single dose bags	200 gr
Bag Gel 400-T	○		400 gr
Bag Gel 200-R	●		200 gr
Bag Gel 400-R	●		400 gr
Ray Gel 300-T	○	2 bicomponent bottles	300 gr
Ray Gel 1000-T	○		1000 gr
Ray Gel 300-R	●		300 gr
Ray Gel 1000-R	●		1000 gr
Ray Gel 10K-T	○	2 bicomponent boxes	10 kg
Ray Gel 20K-T	○		20 kg
Ray Gel 10K-R	●		10 kg
Ray Gel 20K-R	●		20 kg

**Problem TELECOM**

What does a gel for this type of system have to give?

- ✓ **SEALING:**  
Installations also possible in humid environments, flooded wells
- ✓ **DEGREE OF PROTECTION:**  
IP68 in proper casing
- ✓ **PREVENTION FROM OXIDATION:**  
Contacts in Telecom connections shouldn't give attenuations (low signal currents)
- ✓ **HIGH INSULATION FLUIDITY:**  
During casting, the the insulation has to fill all interstitial spaces between the cores of the cable
- ✓ **ANTICRACKING:**  
Insulation in the permanently cold joint should not crack at low temperatures
- ✓ **INSULATION:**  
The filler should be an insulating component

**Solution:** Ray Gel meets all your Telecom system requirements







**IP68**  
OFFICIALLY  
TESTED | **IMQ**  
(in proper casings)

# Wonder Gel

Single component insulating gels in cartridge to instantly protect new installations and oversee maintenance of all types of electrical connections.

**Installer's best friends.** Electrical connections, within empty enclosures, are exposed to the risk of short circuit, oxidation and corrosion, at times, resulting in irreparable damages. Without stress and no waiting around, **WonderGel** and **WonderGel Invisible** make your job easier, guaranteeing the protection and safety of systems in compliance to best practice rules to provide the highest quality solution, quick and perfect to get the satisfaction of both you and your clients.

- Ready to use! No mixing required!  
Already cross-linked! No need to wait!
- Resolve issues connected to incorrect insulation or sealing
- Eliminate annoying out of service instances caused by moisture
- Protect your systems from the penetration of insects
- Protect your electrical connections from oxidation and corrosion
- Italian Utility Model 

VIDEO SURVEILLANCE SYSTEMS



CONNECTIONS IN MOIST ENVIRONMENTS



UNDERGROUND CONNECTIONS

***Time and  
space-saver***

**EASY TO APPLY EVEN  
IN AREAS WHICH ARE  
DIFFICULT TO ACCESS!**



***Always at your  
fingertips!***



INSPECTABLE



EXTERNAL SYSTEMS



UNDERGROUND CONNECTIONS



SMALL-SCALE CONNECTIONS

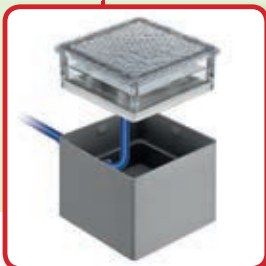

GROUND LUMINAIRES

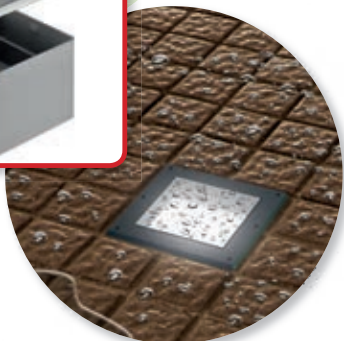

**WHAT IS GEL WONDER?**

- A single component gel
- Extremely sticky
- Stays soft with time
- Never dries
- Non-toxic and safe
- No shelf life



**WHAT DOES GUARANTEE?**

- Maximum insulation and sealing
- Effective and stable adhesion with the passing of time
- High resistance to water pressure
- Degree of protection IP68 when dispensed in suitable casings



**WHY IS IT IN A CARTRIDGE?**

- Always ready to use and at your fingertips
- Can be used with standard guns
- It is measurable
- No waste
- Complete with nozzle
- Extremely rapid to use even in difficult positions
- Compact

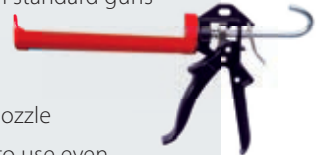



# WonderGel & WonderGel INVISIBLE

## Characteristics

- Single component gel which comes already cross-linked in a cartridge
- No mixing, no waiting time
- Visco-elastic gel which is extremely fluid
- Self-levelling and self-vulcanizing
- Can be applied using standard silicone ratchets
- Easy to measure
- Does not expire and does not harden
- Easy to apply even to inaccessible areas
- Characteristics do not deteriorate with the passing of time
- Re-enterable
- Non-toxic and safe
- Can be applied in all weather conditions, even when raining or in the heat of the summer sun
- Can be applied to powered appliances
- Dielectric strength > 23 kV/mm
- Volume resistivity >  $2 \cdot 10^{15} \Omega \text{ cm}$
- Operating temperature from  $-60 / +200^{\circ}\text{C}$
- Overload temperature for brief periods:  $250^{\circ}\text{C}$
- Gel UL 94-HB

\* Protection degree IP68 in proper casings



## Wonder Gel

Product	Colour	Package type	Total quantity
Wonder Gel	●	Cartridge with measuring nozzle	280 ml
Wonder Gel Invisible	○	Cartridge with measuring nozzle	280 ml

# Gel technology comparison

PRODUCT			
	<b>MAGIC GEL</b> Bi-component gel in 2 bottles	<b>MAGIC POWER GEL</b> Bi-component gel in single, 2 compartment bottle	<b>WONDER GEL</b> Ready-to-use single component gel in a cartridge
METHOD OF APPLICATION	 MIX AND POUR	 1 MIX AND POUR	 INJECT
INSTALLATION TEMPERATURE (°C)	- 5 * -10 ** / +55 -15 ***	- 5 * -10 ** / +55 -15 ***	-40 / +110
OPERATING TEMPERATURE (°C)	-60 / +200	-60 / +200	-60 / +200 Ready to use
CROSS LINKING TIME (minutes at 25°C)	< 10 min.	ca. 15 min.	-
PRINCIPAL CHARACTERISTICS	RE-ENTERABLE	RE-ENTERABLE REUSABLE	INJECTABLE RE-ENTERABLE

\* Poured at -5°C from bottles stored at >10°C.

\*\* Poured at -10°C from bottles stored at >20°C.

\*\*\* Poured at -15°C from bottles stored at -15°C (cross linking within 48 hours).

Raytech gels can be used for the filling and sealing of all junction boxes and are ideal to ensure maximum protection if applied in cable jointing systems of our production.

# Wonder Fluid

Single component insulation fluid gel cartridge.

Gel: UL 94-HB

- Operating temperature:**  
-60°C / +200°C
- Installation temperature:**  
-40°C / +110°C
- Dielectric strength:**  
> 23 kV/mm
- Degree of protection:**  
IP68 (in proper casings)

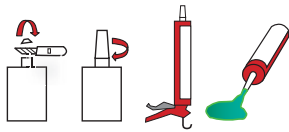

- Ready-to-use fluid gel
- Created for filling new Raytech joint shells with no-return valves
- Suitable for filling trays
- Does not solidify when opened
- No waste
- No shelf life



**IP68**



**IP68**

## Wonder Fluid

Product	Colour	Package type	Total quantity
Wonder Fluid 210	●	Cartridge with measuring nozzle	210 ml
Wonder Fluid 280	●	Cartridge with measuring nozzle	280 ml

# Monogel

Single component transparent insulation gel for generic use.

- Ready to use
- No shelf life



## Monogel

Product	Colour	Package type	Total quantity
Monogel	○	Cartridge with measuring nozzle	300 ml

**Gel:** UL 94-HB

**Operating temperature:**

-60°C / +200°C

**Installation temperature:**

-40°C / +110°C

**Dielectric strength:**

> 23 kV/mm

**Degree of protection:**

IP68 (in proper casings)

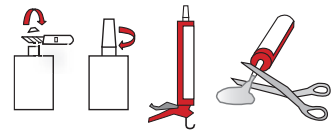

**Ray  
Tech**

# Techno Gel Gum

Single bottle two-component insulation with very high dielectric, thermal and sealing characteristics. Waterproof and re-enterable!

TechnoGelGum is a strong hold flexible elastomer whose formula has been optimised for the protection of POWER CABLE, TELECOM CABLE and ELECTRONIC CIRCUIT connections. A new recipe that gives the product a surprising, original texture that combines the characteristics of GEL and RUBBER to emphasise its features. It's elastic and flexible like gel, but also tough and dry like rubber.

**Dielectric strength:**  
≥ 21 kV/mm  
**Cross linking time:**  
fast (about 10 min. at 25°C)  
**Volume resistivity:**  
>2 x 10<sup>14</sup> Ω cm  
**Operating temperature:**  
-60°C / +200°C  
**Overload temperature  
for short periods:**  
up to 250°C  
**Stabilised for:**  
mould-UV  
**Degree of protection:**  
IP68 (in proper casings)

IP68  
OFFICIALLY  
TESTED | IMQ

- For installations up to 1 kV
- Suitable for high temperatures
- Even suitable for high depths under water
- Waterproof > 1 MPa
- UV resistant
- Removable
- Vibration resistant  
can act as a damper
- Suitable for installation in  
salt water (sea) and in  
chlorinated water (pools)
- Non toxic and safe

EXTREMELY FLEXIBLE  
AND WATER-REPELLENT

NEW EXCEPTIONALLY  
STRONG CONSISTENCY

TECHNO  
**GELGUM**

**FLEXIBLE LIKE GEL**

**STRONG LIKE RUBBER**

**BORN TO BE  
UNIQUE**

Not quite a GEL and not quite RUBBER,  
BUT HAS THE BEST FEATURES OF BOTH!



SAFE



WATERPROOF



RE-ENTERABLE

Product	Colour	Package type	Quantity
Techno Gel Gum	●	1 single, bi-component bottle 1 small basin - 1 mixing spoon	1 kg
Techno Gel Gum 500	●	1 single, bi-component bottle 1 small basin - 1 mixing spoon	500 gr

Installation sequence



Shake before using.



Pour TechnoGelGum into the provided beaker in a 1:1 ratio.



Mix for 1 min. max.



Pour within 1 min. max.



In just 10 minutes the curing is completed.



Ray  
Tech



# GelGum JOINT

Kit composed of 5 joint shells in fracture resistant plastic and 1 kg of Techno Gel Gum, bottled two-component waterproof and re-enterable insulation with very high dielectric, sealing and thermal characteristics. Techno Gel Gum is a strong flexible elastomer whose formula has been optimised for the protection of power cables, Telecom cables and electronic circuit connections. A new recipe that gives the product a surprising, original texture that combines the characteristics of gel and rubber to emphasise its features. It's elastic and flexible like gel, but also tough and dry like rubber.



## GelGum JOINT - L

KIT for line joints

art. **GELGUM JOINT-L**

Kit composed of:

- 1kg of Techno Gel Gum
- +
- 5 casings
- +
- a black 19x25, 0.13 mm-thick tape



Cable formation and conductor cross sections (n° x mm<sup>2</sup>)

	Cable formation and conductor cross sections (n° x mm <sup>2</sup> )			
	1x	2x	3x	4x
<b>4 L10 casings (180x50 mm)</b>	2,5 - 50	1,5 - 10	1,5 - 10	1,5 - 10
<b>1 L25 casing (215x55 mm)</b>	16 - 150	4 - 25	4 - 25	2,5 - 25

## GelGum JOINT - Y

KIT for branch joints

art. **GELGUM JOINT-Y**

Kit composed of:

- 1kg of Techno Gel Gum
- +
- 5 casings
- +
- a black 19x25, 0.13 mm-thick tape



Cable formation and conductor cross sections (n° x mm<sup>2</sup>)

	Cable formation and conductor cross sections (n° x mm <sup>2</sup> )							
	1x		2x		3x		4x	
	T	B	T	B	T	B	T	B
<b>4 LY6 casings (180x90 mm)</b>	4-50	4-50	4-10	4-10	2,5-6	2,5-6	2,5-6	2,5-6
<b>1 Y25 casing (220x105 mm)</b>	50-150	50-150	10-25	10-25	6-25	6-16	6-25	6-10

# Sky Plast

Bicomponent rubber in insulating, mouldable, self-extinguishing paste with high dielectric characteristics.

Thanks to Raytech's constant and careful research and development of new technologies comes Sky Plast, absolute technical innovation for covering, protecting, insulating, finishing and fireproofing any electrical and non-electrical component. Once the 2 components have been blended in a ratio of 1:1 (for max 2 min.) until uniform, it cross links quickly at room temperature in less than 5 minutes. After being wrapped around the component to be protected, Sky Plast quickly transforms into a layer of rubber with high dielectric and self-extinguishing characteristics.

- Low smoke and toxic and corrosive gases emission
- Able to replace taping, heat-shrinking, resin finishes
- Flexible and elastic
- Quickly ready for use

### Installation examples



Cable gland sealing

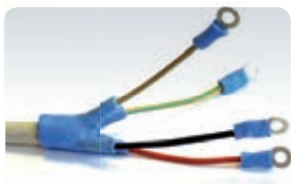

Creation of LV terminals

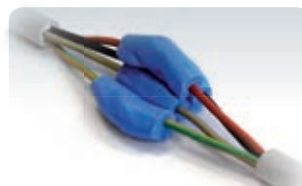

Insulation of multiple connections



Conduit protection

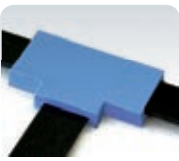

Drop line, bar, transformer through insulation



On-site preparation of braces and supports



Preparation of deflectors, nozzles, flow deviators



Preparation on-site of expanders for inserts



Preparation on-site of small moulds for reliefs



Preparation of bars, washers, round wire insulators



Preparation on-site of seals

### Sky Plast

Product	Colour	Package type	Total quantity
Sky Plast	●	2 bicomponent cans	500 gr
Sky Plast 250	●	2 bicomponent cans	250 gr

**Dielectric strength:**  
> 23 kV/mm  
**Degree of protection:**  
IP68 (in proper casings)



### Installation sequence

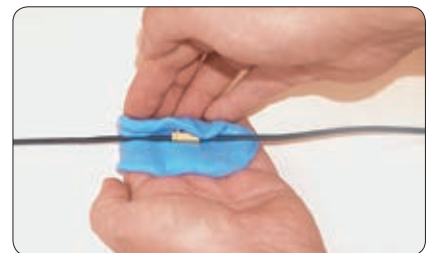

# Magic Rubber

Fast cross linking bicomponent rubber.

Bicomponent insulating liquid rubber, extremely conformable and fluid, flexible, elastic and re-enterable. In just a few minutes, transforms into a rubber with very high dielectric, thermal, mechanical and elastic characteristics.

- Cross linking time:**  
15 minutes at 23°C
- Volume resistivity:**  
>2 10<sup>15</sup> Ω cm
- Dielectric strength:**  
> 23 kV/mm
- Specific weight:**  
1,22 approx
- Degree of protection:**  
IP68 (in proper casings)

- For installation up to 1kV
- Low smoke, toxic and corrosive gas emissions
- Ideal also for casts and moulds
- No shelf life



## Magic Rubber & Rubber Fluid

Product	Colour	Package type	Total quantity
Magic Rubber 500	●	2 bicomponent bottles 1 measuring cup - 1 mixing palette	500 gr
Magic Rubber 10	●	2 bicomponent tanks 1 measuring cup - 1 mixing palette	10 kg
Rubber Fluid 200	●	Bicomponent single dose bags	200 gr
Rubber Fluid 350	●	Bicomponent single dose bags	350 gr



Mix the 2 components in a ratio of 1:1.



Mix for max 30".



Pour the product into the casing to be filled.



In just a few minutes, the product transforms into rubber.

# Rayresin

Bicomponent epoxy resin for installations up to 1 kV.

Resin for electrical insulation and for the protection of thermosetting LV and MV accessories. The two components, the base resin and hardener, are mixed in close contact to trigger the cross linking reaction. Excellent bonding to metal, plastic and rubber components.



**Cross linking time:**

20 minutes at 20°C

**Hardness:**

70 Shore D

**Dielectric strength:**

21 kV/mm

**Specific weight:**

1,07 kg/dm<sup>3</sup>

1,7 kg/dm<sup>3</sup> for Rayresin Tan 3,8

**Water absorption:**

0,8% max



## Rayresin

Product	Colour	Package type	Total quantity
Rayresin 170	●	Bicomponent single dose bags	170 gr
Rayresin 210	●	Bicomponent single dose bags	210 gr
Rayresin 420	●	Bicomponent single dose bags	420 gr
Rayresin Tan 3,8	●	Tin with mineral charge	3.8 kg



Remove the separator from the Rayresin bag.



Mix the 2 components (30" max).

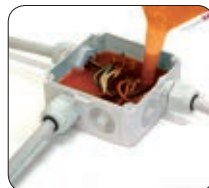

Pour Rayresin in the tray (1" max).



Installation completed.



# IP68 JOINTING BOXES

Universal kits for branch or straight through connections complete with the appropriate amount of gel.



## Power Kit IP68 Solution

CONNECTION KIT WITH POWER GEL

page

96



## Magic Box

CONNECTION KIT WITH MAGIC FLUID

page

100



**Ray  
Tech**



# Wonder Box

IP68 COMPLETE CONNECTION KIT  
ISOLATED WITH WONDER FLUID

page  
99



# J-Box

BRANCH KITS WITH HOOK CLOSING

page  
102



**Electrical Performance:**

CEI EN 60529

**Degree of protection:** IP68

Class 2 in accordance with CEI 64-8.

**Gel:** UL 94-HBOperating temperature **90°**Gel operating temperature **-60°C / +200°C****HF Halogen Free**

in accordance with CEI EN 50267 2-2

**IP68**  
OFFICIALLY TESTED | **IMQ****Ray Tech**

# Power Kit IP68

The only re-enterable and reusable IP68 kit. Can easily be used for ceiling mounted or recessed applications!

The most versatile, safe solution to fully protect connections in boxes with an IP68 degree of protection. Thanks to Magic Power, the newly developed, fast cross-linking, safe and reliable, extremely sticky self-agglomerating gel with very high dielectric, thermal and elastic characteristics, sealing is guaranteed in all type of installation, including submerged. The Power Kit IP68 solution is the only product of its kind! Not only because the insulation can be used in two different ways, both as a traditional "pour" in the box and as a "cross linked and sticky" product (cross linking first), but also because, thanks to its re-enterability and re-usability, it helps you save time and money!

- Kit complete with perfect IP68 connection
- Insulated with **Magic Power Gel** the innovative self-amalgamating gel
- Can also be used in severe environmental conditions
- Suitable for very high depths
- No waste
- No shelf life

**WHERE CAN YOU USE THE POWER KIT?**

In pools, tanks, submerged pumps, outdoor lighting systems, underground, port piers, marinas, sewer systems, and with temporary connections such as with lights, street vendors, etc.

**HOW DO YOU USE THE POWER KIT?**

The insulation can be poured into the box (Pour!) or, for special applications, cross linked in the measuring beaker and applied around the connection (Stick!). Mix the Magic Power gel in a 1:1 ratio in the supplied measuring beaker. The gel will cross link in less than 15 minutes.

**NO WASTE**

The cross linked gel which remains on the bottom after mixing can be easily removed from the beaker and saved for later use.



Chose the **POUR** or **STICK** method most suited for your needs

**POUR**



You can use the Magic Power gel supplied in the bicomponent bottle in a 1:1 ratio by simply pouring it after mixing into the box supplied in the kit, to protect and seal internal connections. The gel cross links in just 15 minutes, but the box can be energised immediately.

RE-ENTER AND RE-USE



Thanks to Magic Power Gel, the box can be **re-opened, inspected** and **re-insulated** all using the original installed product.

**STICK**



Pour the components in the measuring beaker, mix and leave to cross link (about 15 minutes). Remove the insulation and position it in small parts around the connection so that it is fully covered. Insulation saved from previous mixes can of course be utilised.

IN A HURRY? ADVERSE WEATHER CONDITIONS? PREPARE YOUR INSULATION BEFORE INSTALLING IT!

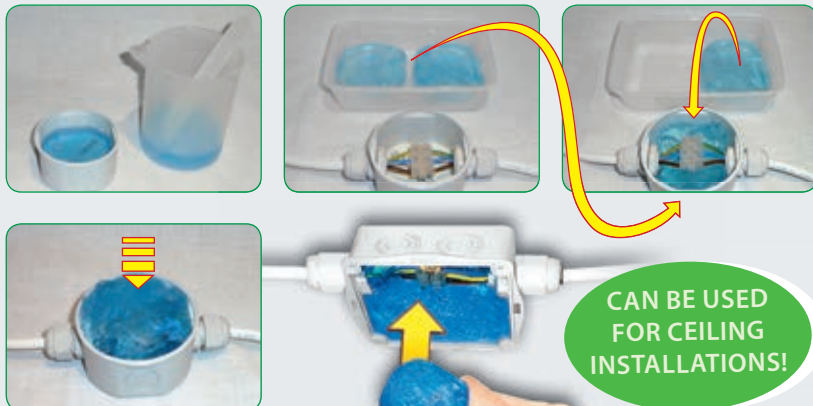





#### WHAT ARE THE ADVANTAGES TO USING THE POWER KIT?

- The insulation is extremely sticky and self-amalgamating, with no shelf life, it is non-toxic and it adheres to everything while leaving your hands clean and dry.
- The kit does not cause waste: insulation left over in the measuring beaker can be saved for later use.
- Re-enterable and reusable, saving time and money.
- The supplied box has pre-marked holes.
- Compatible with Magic Gel.
- A slight exothermic reaction (temperature increase of about 3°C) speeds up cross linking in cold weather conditions.
- Even protects boxes mounted on the ceiling to IP68 if using the "stick" method. Could also use left over product from previous installations.
- Insulation can be pre-prepared: at home, at work or in your car and then applying it once cross linked, saving time when you're in a hurry or in adverse weather conditions.

#### SOME LEFT OVER? SAVE IT!

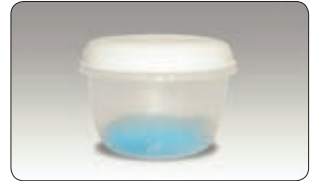

Left over gel that has already cross linked can be easily removed from the measuring beaker and saved for later use.



**Ray Tech**

#### Power Kit

Product	Box	Insulating
Power Kit 65	mm Ø 65 x h 35 + 2 cable glands PG16 / caps	Single bicomponent bottle 1 small basin - 1 mixing spoon
Power Kit 80	mm Ø 80 x h 40 + 3 cable glands PG16 / caps	Single bicomponent bottle 1 small basin - 1 mixing spoon
Power Kit 100	mm 100 x 100 x h 50 + 3 cable glands M25 x 1,5 / caps	Single bicomponent bottle 1 small basin - 1 mixing spoon
Power Kit 120	mm 120 x 80 x h 50 + 3 cable glands M25 x 1,5 / caps	Single bicomponent bottle 1 small basin - 1 mixing spoon

# Wonder Box IP68

## Complete IP68 connection kit insulated with Wonder Fluid.

Universal IP68 kit with no shelf life, mechanically robust, non-toxic, suitable for installation in even the most extreme conditions and re-enterable.

Protects from water, moisture, dust and accidental contact caused by insects.



**IP68**  
OFFICIALLY  
TESTED | **IMQ**

## WonderBOX 65

Cod. **Wonder Box 65**

2 box Ø 65 x h 35 mm

+

4 cable glands PG16 / caps

+

1 single component cartridge



## WonderBOX 80

Cod. **Wonder Box 80**

1 box Ø 80 x h 40 mm

+

3 cable glands PG16 / caps

+

1 single component cartridge



**Electrical Performance:**  
CEI EN 60529

**90°** Operating temperature

**Gel:** UL 94-HB

**Gel** operating temperature:  
-60°C / +200°C

**HF** Halogen Free

in accordance with  
CEI EN 50267 2-2

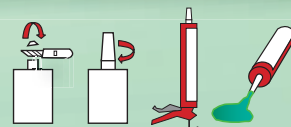





# Magic Box

**Electrical Performance:**  
CEI EN 60529

**Degree of protection:** IP68  
Class 2 in accordance  
with CEI 64-8.

**Gel:** UL 94-HB  US

Operating temperature 

Gel operating temperature   
-60°C / +200°C

**HF** *Halogen Free*

in accordance with  
CEI EN 50267 2-2

**IP68**  
OFFICIALLY  
TESTED 

IP68 Connection kit complete with Magic Fluid insulating gel.

Universal IP68 kit without shelf life, mechanically robust, non-toxic, suitable for installation even in the most extreme conditions, re-enterable, meeting all international standards. Protects from water, moisture, dust and accidental contact caused by small animals.

- Re-enterable even after long periods of operation
- Able to absorb external shock without fracturing
- For installations even at high depths
- Also suitable for vertical filling
- No shelf life
- Non toxic and safe



Magic Box is suitable for any kind of installation, even underground or directly submerged!



Magic Box is always re-enterable, even after long working periods!

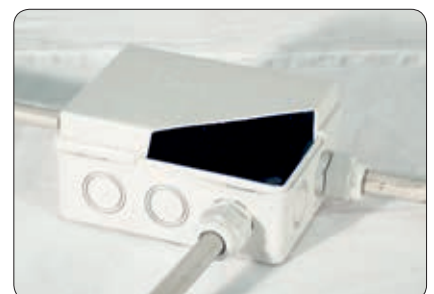



Kit box installation sequence

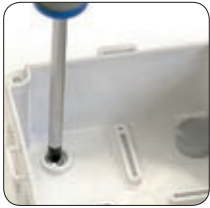

Fix the box and cover the screws with the caps.

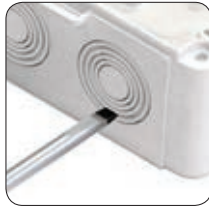

Knock out the pre prepared holes.



Install the cable glands.

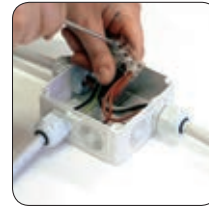

Insert the cables and connect the wires.

Horizontal installation sequence

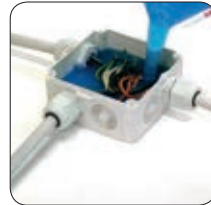

Vertical installation sequence



Examples of application



PUBLIC LIGHTING



NAVAL SECTOR



OUTDOOR - GARDENS



ELECTRIC GATES

Magic Box

Product	Max external Ø housed in input cables (mm)	N° and type of cable glands	Internal kit dimensions (mm)	Composition Kit
Magic Box 65	22	3 x PG16	Ø 65 x h 35	Kit complete with cover 3 cable glands Series of closing plugs Insulating gel for complete filling
Magic Box 80	22	3 x PG16	Ø 80 x h 40	
Magic Box 100	20	3 x M25 x 1.5	100 x 100 x h 50	
Magic Box 120	20	3 x M25 x 1.5	120 x 80 x h 50	
Magic Box 150	26	3 x M25 x 1.5	150 x 110 x h 70	
Magic Box 190	26	3 x M25 x 1.5	190 x 140 x h 70	
Magic Box 240	26	3 x M25 x 1.5	240 x 190 x h 90	





# J-Box

Snap shut closing enclosures with perforated knockouts.

**Electrical Performance:**

CEI 23-48, IEC 60670

**Degree of protection:**

empty IP55  
filled with Gel Raytech IP68

**Halogen free:**

according to CEI EN 50267 2-2

**Self-extinguishing and resistant to abnormal heat and fire:**

Glow wire test a +960°C according to EN 60695-2-11

Enclosure with snap shut cover and perforated knockouts for faster mounting of cable glands. Very high mechanical and flame retardant properties. Non-toxic, re-enterable only by means of a tool. The screwless design prevents screws rusting over time due to moisture and always allows for easy re-entry. Screw caps are also supplied for the wall mounting screws along with 3 cable glands and a stopping plug for vertical filling.

- Can be insulated with **Magic Power Gel, Magic Gel, Wonder Gel (IP68)**
- Re-enterable only with the use of a tool
- Snap-shut closing (without screws)
- Also suitable for vertical filling
- Excellent shock-resistance
- Self-extinguishing
- Halogen Free

Snap-shut closing (without screws)



Pre - drilled walls





## J-Box

Enclosures with perforated knockouts.

Product	N° max of cables that can be jointed	Ø max predrilling holes (mm)	Ø max possible drilling (mm)	Max dimension housed cable glands (pass)		Dimension (mm)
				PG	METRIC	
J-BOX 65	4	23	23	16	20	Ø 65 x h 35
J-BOX 80	4	23	23	16	20	Ø 80 x h 40
J-BOX100	8	29	29	21	25	100 x 100 x h 50
J-BOX120	6	25	29	21	25	120 x 80 x h 50
J-BOX150	10	29	37	29	32	150 x 110 x h 70
J-BOX190*	10	37	37	29	32	190 x 140 x h 70
J-BOX240*	12	37	37	29	32	240 x 190 x h 90

\* Supplied with extractable hinge for opening book type.  
Note: All boxes include 3 cable glands Ray Pass 16.



## Accessories

### Ray-PRESS

Cable glands.

METRIC pict Product	Metric pict	Assembly hole Ø (mm)	Cable range Ø		Item packaging
			min (mm)	max (mm)	
Ray PRESS-16	M16 x 1.5	16	6	10	50
Ray PRESS-20	M20 x 1.5	20	8	13	50
Ray PRESS-25	M25 x 1.5	25	12	18	20
Ray PRESS-32	M32 x 1.5	32	16	20	20

PG pict Product	PG pitch	Assembly hole Ø (mm)	Cable range Ø		Item packaging
			min (mm)	max (mm)	
Ray PRESS-PG11	11	19	6	9	50
Ray PRESS-PG13.5	13,5	20	9	12	50
Ray PRESS-PG16	16	23	11	14	50
Ray PRESS-PG21	21	29	14	18	20



### Ray-PASS

Rubber flexible grommets.

Product	For pipe maximum external Ø (mm)	Assembly hole Ø (mm)	Item packaging
Ray PASS 16	20	23	50
Ray PASS 21	23,5	29	50
Ray PASS 29	32	38	50





# Connectors

**Temperature of use:**  
-5°C / +50°C  
**Insulation resistance:**  
> 100 MΩ  
**Reference standards:**  
CEI EN 50086-2-1

Self-extinguishing rigid PVC accessories  
V0 - Standard UL94.



## Ray RTC

Tube box connectors IP65 grey RAL 7035.

Product	Tube Ø (mm)	Item packaging
Ray RTC 16	16	50
Ray RTC 20	20	50
Ray RTC 25	25	50
Ray RTC 32	32	25
Ray RTC 40	40	20
Ray RTC 50	50	10



## Ray RGC

Box straight connectors IP65 grey RAL 7035.

Product	Tube Ø (mm)	Item packaging
Ray RGC 16	16	50
Ray RGC 20	20	50
Ray RGC 25	25	25
Ray RGC 32	32	25
Ray RGC 40	40	20
Ray RGC 50	50	10



## Ray CF

Flexible tube box bend IP65 grey RAL 7035.

Product	Tube Ø (mm)	Item packaging
Ray CF 16	16	70
Ray CF 20	20	60
Ray CF 25	25	50
Ray CF 32	32	30
Ray CF 40	40	20
Ray CF 50	50	10



# J-Box KIT IP68 - Do It Yourself

Choose the box, the cable glands and the filler shown in the selection table. In just 3 steps you have a specific IP68 box just for you!

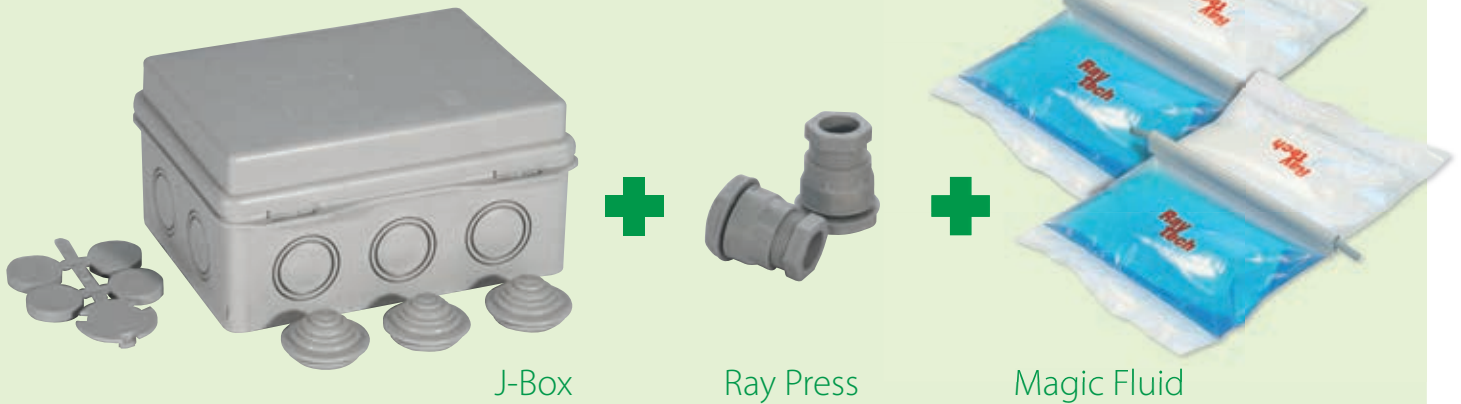

Box type	Dimensions (mm)	Type of cable glands to be housed PG and metric pitch M	Insulating filler Magic Fluid*
J-Box 65	Ø 65 x 35	PG: 7 - 9 - 11 - 13,5 - 16 M: 12 - 16 - 20	1 x Magic Fluid 110
J-Box 80	Ø 80 x 40	PG: 7 - 9 - 11 - 13,5 - 16 M: 12 - 16 - 20	1 x Magic Fluid 210
J-Box 100	100 x 100 x h 50	PG: 7 - 9 - 11 - 13,5 - 16 - 21 M: 12 - 16 - 20 - 25	1 x Magic Fluid 420
J-Box 120	120 x 80 x h 50	PG: 7 - 9 - 11 - 13,5 - 16 - 21 M: 12 - 16 - 20 - 25	1 x Magic Fluid 420
J-Box 150	150 x 110 x h 70	PG: 13,5 - 16 - 21 - 29 M: 20 - 25 - 32	2 x Magic Fluid 420
J-Box 190	190 x 140 x h 70	PG: 13,5 - 16 - 21 - 29 M: 20 - 25 - 32	2 x Magic Fluid 420 1 x Magic Fluid 550
J-Box 240	240 x 190 x h 90	PG: 13,5 - 16 - 21 - 29 M: 20 - 25 - 32	4 x Magic Fluid 550 + 2 x Magic Fluid 210

\*Note: the indicated quantities are for the complete filling of the box.





# SHEATHS

Thin, Medium, Heavy-wall  
heat shrink supplied in  
dispensers, coils, bars,  
wrap around and pieces.

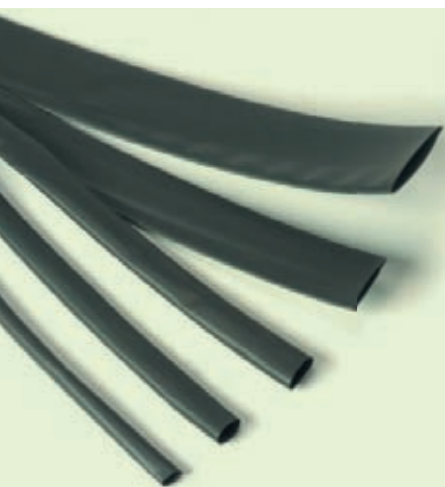



# Heat-shrink sheaths

## THIN-WALL



**LST-TEC**  
Sheaths in dispensers for commercial use



**RayRoll / MaxiRoll**  
Sheaths in dispensers for industrial use

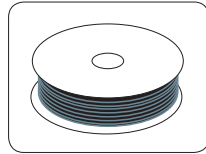

**CGP-TEC**  
Sheaths in coils or commercial use

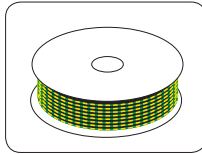

**DCP-TEC**  
Sheaths in coils for grounding cables



**RDCT-B**  
Tubes in bars for general use

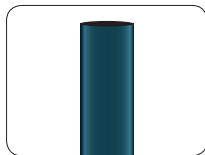

**RGPO-B**  
Tubes in bars for general use

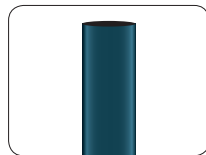

**Ray-Tum**  
Semi-flexible sheath in bars



**Thermo Mini Mix**  
Precut sheath kit

## MEDIUM WALL

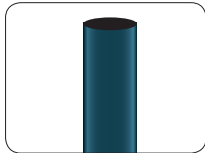

**MTR**

## HEAVY WALL

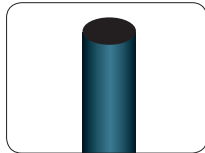

**Ray-CSM**

## WRAP AROUND

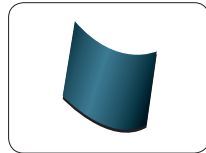

**Ray-RSM**  
Winding sheath

## POLE PROTECTION

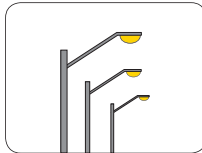

**WPC / LTPSM**  
Sheaths for lighting poles



Colour table

- Black
- Red
- Blue
- Yellow
- White
- ⊙ Transparent
- Yellow Green

# Moulded parts

## CAPS

Self-sealing cap



## TERMINATIONS

LV terminations

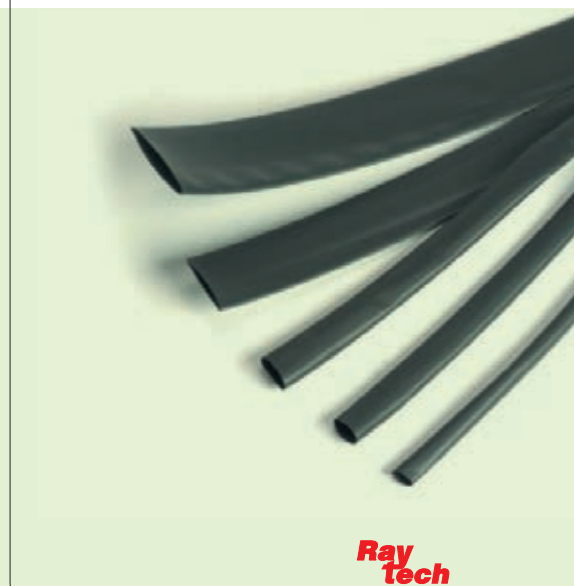



Tensile resistance	14,8 MPa
Elongation	460 %
Tensile resistance after ageing	14,5*
Elongation after ageing	480 %*
Dielectric strength	17 kV/mm*
Flammability	VW1*
Minimum shrinkage temperature	70°C

\* (UL 224 test method)

# Thin-wall sheaths

Flexible heat-shrink modified polyolefin sheaths, cross linked by means of radiation. Longitudinal shortening up to 15%. Suitable for insulation and covering of conductors and their connections, bars, etc. Replace self-adhesive, self-amalgamating insulating tapes.

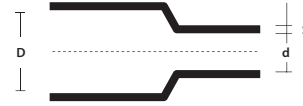

“UL” standard

Operating temperature: -55°C / +120°C

D = Ø min. before shrinkage

d = Ø max. after free shrinkage

S = min. rated thickness after free shrinkage (+/- 20%)



## LST-TEC

Heat-shrink in dispensers for commercial use.

Product	Colour	D (mm)	d (mm)	S (mm)	Length (m)
LST-TEC 1,6	● ●	1,6	0,8	0,50	10
LST-TEC 2,4	● ●	2,4	1,2	0,55	10
LST-TEC 3,2	● ●	3,2	1,6	0,55	10
LST-TEC 4,8	● ●	4,8	2,4	0,55	9
LST-TEC 6,4	● ●	6,4	3,2	0,65	8
LST-TEC 9,5	● ●	9,5	4,8	0,65	6
LST-TEC 12,7	● ●	12,7	6,4	0,65	6
LST-TEC 19,0	● ●	19,0	9,5	0,80	5
LST-TEC 25,4	● ●	25,4	12,7	0,95	3
LST-TEC-GV 3/1,5	● ●	3	1,5	0,51	7
LST-TEC-GV 4,8/2,4	● ●	4,8	2,4	0,55	10
LST-TEC-GV 6/3	● ●	6	3	0,58	5
LST-TEC-GV 10/5	● ●	10	5	0,64	4
LST-TEC-GV 12/6	● ●	12	6	0,65	7
LST-TEC-GV 19/9	● ●	19	9	0,74	3
LST-TEC-GV 26/13	● ●	26	16	0,89	2,5



## Ray Roll

Heat-shrink in dispensers for industrial use.

Product	Colour	D (mm)	d (mm)	S (mm)	Length (m)
Ray Roll 1,6	●	1,6	0,8	0,50	20
Ray Roll 2,4	●	2,4	1,2	0,55	20
Ray Roll 3,2	●	3,2	1,6	0,55	10
Ray Roll 4,8	●	4,8	2,4	0,55	10
Ray Roll 6,4	●	6,4	3,2	0,65	10
Ray Roll 9,5	●	9,5	4,8	0,65	10
Ray Roll 12,7	●	12,7	6,4	0,65	10
Ray Roll 19,0	●	19,0	9,5	0,80	5
Ray Roll 25,4	●	25,4	12,7	0,95	5

## Maxi Roll

Heat-shrink in maxi dispensers for industrial use.

Product	Colour	D (mm)	d (mm)	S (mm)	Length (m)
Maxi Roll 1,6	●	1,6	0,8	0,50	300
Maxi Roll 2,4	●	2,4	1,2	0,55	300
Maxi Roll 3,2	●	3,2	1,6	0,55	300
Maxi Roll 4,8	●	4,8	2,4	0,55	150
Maxi Roll 6,4	●	6,4	3,2	0,65	75
Maxi Roll 9,5	●	9,5	4,8	0,65	150
Maxi Roll 12,7	●	12,7	6,4	0,65	150
Maxi Roll 19,0	●	19,0	9,5	0,80	75
Maxi Roll 25,4	●	25,4	12,7	0,95	60



## CGP-TEC

Sheath for commercial use.

Product	Colour	D (mm)	d (mm)	S (mm)	Spool (m)
CGP-TEC 1,2/0,6	●●●●○Ⓟ	1,2	0,6	0,45	600
CGP-TEC 1,6/0,8	●●●●○Ⓟ	1,6	0,8	0,45	300
CGP-TEC 2,4/1,2	●●●●○Ⓟ	2,4	1,2	0,50	300
CGP-TEC 3,2/1,6	●●●●○Ⓟ	3,2	1,6	0,50	300
CGP-TEC 4,8/2,4	●●●●○Ⓟ	4,8	2,4	0,50	150
CGP-TEC 6,4/3,2	●●●●○Ⓟ	6,4	3,2	0,65	75
CGP-TEC 9,5/4,8	●●●●○Ⓟ	9,5	4,8	0,65	150
CGP-TEC 12,7/6,4	●●●●○Ⓟ	12,7	6,4	0,65	150
CGP-TEC 19/9,5	●●●●○Ⓟ	19,0	9,5	0,75	75
CGP-TEC 25,4/12,7	●●●●○Ⓟ	25,4	12,7	0,90	60
CGP-TEC 38/19	●●●●○Ⓟ	38,0	19,0	1,00	60
CGP-TEC 51/26	●●●●○Ⓟ	51,0	26	1,15	30
CGP-TEC 76/38	●●●●○Ⓟ	76,0	38,0	1,27	15
CGP-TEC 102/51	●●●●○Ⓟ	102,0	51,0	1,40	15

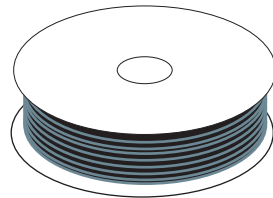

## DCP-TEC

Sheath suitable for coating grounding cables.

Product	Colour	D (mm)	d (mm)	S (mm)	Spool (m)
DCP-TEC 3/1,5	●●	3,0	1,5	0,51	300
DCP-TEC 6/3	●●	6,0	3,0	0,58	75
DCP-TEC 10/5	●●	10,0	5,0	0,64	75
DCP-TEC 12/6	●●	12,0	6,0	0,64	75
DCP-TEC 19/9	●●	19,0	9,0	0,74	75
DCP-TEC 26/13	●●	26,0	13,0	0,89	30
DCP-TEC 38/19	●●	38,0	19,0	1,00	30

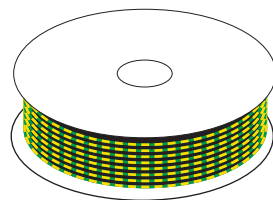



Minimum shrinkage temperature **125°**

Operating temperature: **-55°C / +125°C**

Tensile resistance	14,8 MPa
Elongation	460 %
Tensile resistance after ageing	14,5*
Elongation after ageing	480 %*
Dielectric strength	17 kV/mm*
Flammability	VW1*

\* (UL 224 test method)

## Sheaths in bars

Flexible heat-shrink modified polyolefin sheaths, cross linked by means of radiation. Longitudinal shortening up to 15%. Suitable for insulation and covering of conductors and their connections, bars. etc. Replace self-adhesive, self-amalgamating insulating tapes.

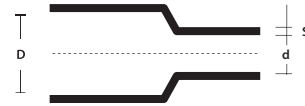
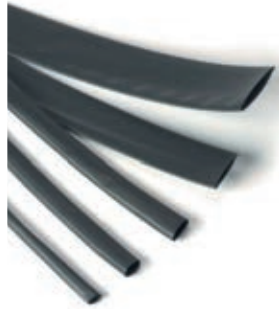

D = Ø min. before shrinkage

d = Ø max. after free shrinkage

S = min. rated thickness after free shrinkage (+/- 20%)

## RDCT-B

Yellow green tube for general use in bars.



Product	Colour	D (mm)	d (mm)	S (mm)	Bars (m)
RDCT-B 3/1,5		3,0	1,5	0,51	1,2
RDCT-B 6/3		6,0	3,0	0,58	1,2
RDCT-B10/5		10,0	5,0	0,64	1,2
RDCT-B 12/6		12,0	6,0	0,64	1,2
RDCT-B 19/9		19,0	9,0	0,74	1,2
RDCT-B 26/13		26,0	13,0	0,89	1,2

## RGPO-B

Tube for general use in bars.



Product	Colour	D (mm)	d (mm)	S (mm)	Bars (m)
RGPO-B 2,4/1,2		2,4	1,2	0,50	1,2
RGPO-B 3,2/1,6		3,2	1,6	0,50	1,2
RGPO-B 4,8/2,4		4,8	2,4	0,50	1,2
RGPO-B 6,4/3,2		6,4	3,2	0,65	1,2
RGPO-B 9,5/4,8		9,5	4,8	0,65	1,2
RGPO-B 12,7/6,4		12,7	6,4	0,65	1,2
RGPO-B 19/9,5		19,0	9,5	0,75	1,2
RGPO-B 25,4/12,7		25,4	12,7	0,90	1,2
RGPO-B 38/19		38,0	19,0	1,00	1,2
RGPO-B 51/26		51,0	26	1,15	1,2



# Ray-TUM

Sheaths in bars with adhesive.

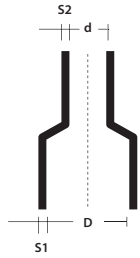

D = Ø min. before shrinkage  
 d = Ø max. after free shrinkage  
 S1 = rated thickness as supplied  
 S2 = min. rated thickness after free shrinkage

Shrinkage ratio 3:1						
Product	Colour	D (mm)	d (mm)	S <sub>2</sub> (mm)	S <sub>1</sub> (mm)	Bars (m)
Ray-TUM-3/1-0	●	3	1	1,00	0,5	1,2
Ray-TUM-6/2-0	●	6	2	1,00	0,5	1,2
Ray-TUM-9/3-0	●	9	3	1,40	0,6	1,2
Ray-TUM-12/4-0	●	12	4	1,75	0,7	1,2
Ray-TUM-19/6-0	●	19	6	2,25	0,8	1,2
Ray-TUM-24/8-0	●	24	8	2,50	1,0	1,2
Ray-TUM-40/13-0	●	40	13	2,50	1,0	1,2

Shrinkage ratio 4:1						
Product	Colour	D (mm)	d (mm)	S <sub>2</sub> (mm)	S <sub>1</sub> (mm)	Bars (m)
Ray-TUM-4/1-0	●	4	1	1,00	0,5	1,2
Ray-TUM-8/2-0	●	8	2	1,00	0,5	1,2
Ray-TUM-12/3-0	●	12	3	1,40	0,6	1,2
Ray-TUM-16/4-0	●	16	4	1,75	0,7	1,2
Ray-TUM-24/6-0	●	24	6	2,25	0,8	1,2
Ray-TUM-32/8-0	●	32	8	2,50	1,0	1,2
Ray-TUM-52/13-0	●	52	13	2,50	1,0	1,2



125° Minimum shrinkage temperature

Operating temperature: -55°C / +120°C

Tensile resistance	ISO 37	9 MPa (min)
Elongation	ISO 37	300 % (min)
Internal wall adhesion	-	60 N x 25 mm (min)
Thermal shock	4 h at 225°C	No-drip No breaking
Thermal ageing	168 h at 225°C	No-drip No breaking
Flexibility at low temperature	4 h at -55°C	No breaking
Dielectric strength	IEC 243	12 MV/m (min)
Resistance to fluids (lubricant oil, hydraulic fluid, diesel)	ISO 37	Tensile resistance 7 Mpa (min)
	24 h	Elongation: 300% (min)
	at 23°C	Adhesion to int. walls: 60 N x 25 mm (min)

# Thermo Mini Mix

Pre-cut heat-shrink sheaths kit.

Ready-for-installation heat-shrink sheaths in a practical, convenient kit sub-divided by diameter. Indispensable for Electrical systems, as a replacement for taped insulation, wiring of all types, switchboards, Hi-Fi, hobbies, DIY.

- Wide range of diameters and colours
- Always ready, quick application
- Flexible



COLOUR BLACK	MIXED COLOURS	Ø before and after shrinkage (mm)	Length of sheath (mm)	Pieces in the kit
Thermo Mini Mix-N	Thermo Mini Mix-MC	1,0 / 0,5	97	60
		2,0 / 1,0	97	40
		3,0 / 1,5	97	30
		4,5 / 2,25	97	20
		6,0 / 3,0	97	10
		9,0 / 4,5	97	10



125° Minimum shrinkage temperature

Operating temperature: -55°C / +120°C





Minimum shrinkage temperature **125°**

Operating temperature: **-55°C / +125°C**

**HF** Halogen Free

Tensile resistance	14,8 MPa
Elongation	460 %
Tensile resistance after ageing	14,5*
Elongation after ageing	480 %*
Dielectric strength	17 kV/mm*

\* (UL 224 test method)

# Medium-wall sheaths

Heat-shrink modified polyolefin sheaths, cross linked by means of radiation for insulation, sealing and LV component protection. It is in fact used for restoring insulation and for the outer covering of LV cables and wherever optimal mechanical characteristics are required for resistance to impact, abrasion, general weathering including UV radiation, or for use in under water environments. Used for the insulation of bars or naked LV connections with optimal mechanical resistance for sealing, especially if used with hot-melt adhesive, and for anti-corrosion protection. Also replaces self-adhesive and self-amalgamating tapes.

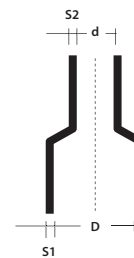

**D** = Ø min. before shrinkage  
**d** = Ø max. after free shrinkage  
**S1** = rated thickness as supplied  
**S2** = min. rated thickness after free shrinkage

## MTR

### WITH OR WITHOUT ADHESIVE

Product	Applications by diameters from (mm)	to (mm)	D (mm)	d (mm)	S <sub>1</sub> (mm)	S <sub>2</sub> (mm)
MTR 10/3*	3,5	9,0	10	3	0,3	1,0
MTR 16/5*	5,5	14,0	16	5	0,3	1,4
MTR 25/8*	8,5	22,0	25	8	0,4	2,0
MTR 35/12*	13,0	32,0	35	12	0,4	2,0
MTR 50/16*	17,5	45,0	50	16	0,5	2,0
MTR 63/19*	21,0	57,0	63	19	0,6	2,4
MTR 75/22*	24,0	68,0	75	22	0,6	2,7
MTR 85/25*	28,0	77,0	85	25	0,6	2,8
MTR 95/29*	32,0	86,0	95	29	0,7	3,1
MTR 115/34*	37,0	104,0	115	34	0,7	3,1
MTR 140/42*	46,0	126,0	140	42	0,7	3,1
MTR 160/55*	55,0	144,0	160	55	0,7	3,2
MTR 180/60*	66,0	162,0	180	60	0,7	3,2

\* Complete the item code adding the length (in mm), adhesive (/172) or without adhesive (/U).

## MTN

### Suitable for submersible pumps

#### WITH ADHESIVE

Product	Applications by diameters from (mm)	to (mm)	D (mm)	d (mm)	S <sub>1</sub> (mm)	S <sub>2</sub> (mm)
MTN 10/3*	3,5	9,0	10	3	0,3	1,0
MTN 16/5*	5,5	14,0	16	5	0,3	1,4
MTN 25/8*	8,5	22,0	25	8	0,4	2,0
MTN 35/12*	13,0	32,0	35	12	0,4	2,0
MTN 50/16*	17,5	45,0	50	16	0,5	2,0
MTN 63/19*	21,0	57,0	63	19	0,6	2,4
MTN 75/22*	24,0	68,0	75	22	0,6	2,7
MTN 85/25*	28,0	77,0	85	25	0,6	2,8
MTN 95/29*	32,0	86,0	95	29	0,7	3,1
MTN 115/34*	37,0	104,0	115	34	0,7	3,1

\* Complete the item code adding the length (in mm).

# Heavy-wall sheaths

RAY-CSM heat-shrink tubular sheath is very thick and has been designed for uses requiring exceptional mechanical characteristics. Its ideal field of application is in underwater or directly underground environments, or where exceptional resistance to abrasion and impact is required, but also outstanding resistance to weathering, including UV radiation, for sealing, especially if used with hot-melt adhesive, and for anti-corrosion protection.

## Ray-CSM

Product	Applications by diameters		D	d	S <sub>1</sub>	S <sub>2</sub>
	from (mm)	to (mm)	(mm)	(mm)	(mm)	(mm)
Ray-CSM 12/3*	3,5	10	12	3	0,8	2,0
Ray-CSM 16/4*	4,5	14	16	4	0,9	2,4
Ray-CSM 24/6*	6,5	22	24	6	1,0	2,7
Ray-CSM 34/8*	9	31	34	8	1,3	4,0
Ray-CSM 48/12*	13	44	48	12	1,5	4,5
Ray-CSM 56/16*	17,5	50	56	16	1,5	4,4
Ray-CSM 70/21*	22	63	70	21	1,4	4,4
Ray-CSM 90/25*	27	81	90	25	1,3	4,3
Ray-CSM 110/30*	33	100	110	30	1,2	4,3
Ray-CSM 130/36*	38	118	130	36	1,2	4,3
Ray-CSM 160/50*	55	144	160	50	1,0	4,3
Ray-CSM 180/50*	55	162	180	50	1,0	4,3

\* Complete the item code adding the length (mm), adhesive (/172).

# Wrap Around

Winding heat-shrink sheath for repairing plastic or metal cable sheaths. It combines the previously seen mechanical, protective and sealing properties of tubular junctions with easy of application and closing. Indispensable when cable cutting is not possible. Does not require pre-insertion, reducing the space necessary for its application.

## Ray-RSM

Product	Ø cable		D	d
	from (mm)	to (mm)		
Ray-RSM 34/10*	12	21	34	10
Ray-RSM 53/13*	15	32	53	13
Ray-RSM 84/20*	23	50	84	20
Ray-RSM 107/29*	34	65	107	29
Ray-RSM 143/36*	42	86	143	36
Ray-RSM 198/55*	62	120	198	55
Ray-RSM 250/98*	111	150	250	98

\* Complete the item code adding the length (mm) and adhesive (/232).

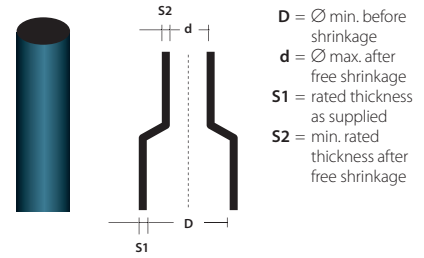

**125°** Minimum shrinkage temperature

**U** Operating temperature: -55°C / +120°C

**HF** Halogen Free

Tensile resistance	ISO 37	12 MPa (min)
Elongation	ISO 37	350 % (min)
Thermal duration	IEC 60216	120°C
Dielectric strength	IEC 60243	1 mm wall
		180 kV/cm
		3.5 mm wall
		120 kV/cm

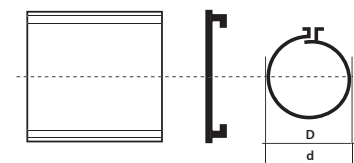

**HF** Halogen Free

Tensile resistance	ISO 37	17 MPa (min)
Elongation	ISO 37	350 % (min)
Density	ISO 1183	1,0-1,2 g/cm <sup>3</sup>
Hardness	ISO 868	50-70 Shore D
Thermal duration	IEC 60216	120°C
Flexibility at low temperature	4 h at -40°C ASTM D2671	Non-cracking
Dielectric strength	IEC 60243	1 mm wall
		180 kV/cm
		3.5 mm wall
		120 kV/cm



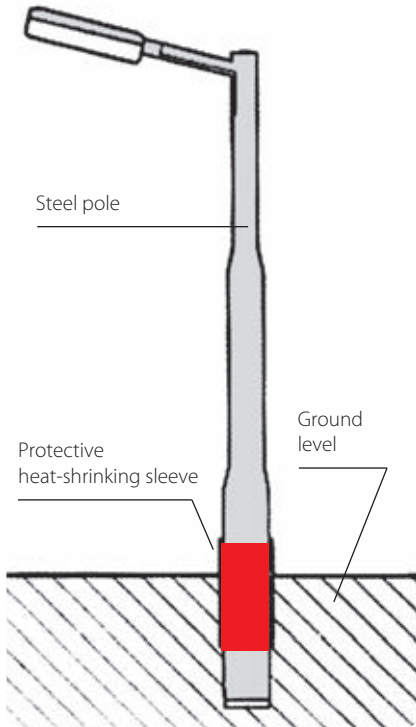

# Anti-corrosion pole protection

On installed poles, the most section vulnerable to corrosion is right above and below ground. This section is attacked by corrosive agents that cause a rapid decay of the metal with a significant reduction of the operating life of the pole. Special heat-shrinking sheaths are suitable for the rust protection of public lighting and electric traction poles, traffic lights and traffic signs. They are composed of very thick cross linked polyolefin. The inside of the tubes and the ends are covered in a suitable thermal fuse adhesive that ensures perfect sealing without allowing moisture to enter.

- Ultra adhesive
- Excellent electrical properties
- Good chemical resistance
- Resistant to mould and micro-organisms
- Constant protection against stray electrical currents
- Easy application
- Long-term stability of all properties



## WPCT

Open ends complete with closing pieces for already installed poles.

Product	End height (mm)	Package roll (m)	Code for closing piece for pole diameter	
			Up to 450 mm	Over 450 mm
WPCT-17X100-RL	450	30	WPCP-IV-4X17	WPCP-IV-6X17
WPCT-24X100-RL	600	30	WPCP-IV-4X24	WPCP-IV-6X24

Closing pieces sold separately



## LTPSM

Tubular sleeve for poles for installation.

Product	Diameter before/after shrinkage (mm)	Sleeve length (mm)
LTPSM 180/58-500	180/58	500
LTPSM 245/80-500	245/80	500



# Self-sealing cap

Self-sealing heat-shrink cap with adhesive for sealing cable heads.

Product	Ø cable		D (mm)	d (mm)	S (±20% mm)	L1 (±10% mm)
	from (mm)	to (mm)				
RayL011	4	8	12	4,0	2,0	40
RayL022	8	17	20	6	2,3	55
RayL033	17	30	35	16	3,0	83
RayL044	30	45	55	26	3,3	103
RayL048	45	65	75	36	3,3	120
RayL055	65	95	100	52	3,8	140
RayL066	95	115	120	60	3,8	150

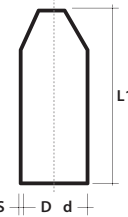

D = Ø min. before shrinkage  
d = Ø max. after free shrinkage  
S-L1 = min. rated size after free shrinkage



**HF** Halogen Free

Tensile resistance	ISO 37	12 MPa (min)
Elongation	ISO 37	200 % (min)
Density	ISO 1183	0,9-1,2 g/cm <sup>3</sup>
Hardness	ISO 868	50-70 Shore D
Accelerated ageing (7 days at 150°C) ISO 188	Tensile resistance ISO 37	12 Mpa (min)
	Ultimate elongation ISO 37	200% (min)
Flexibility at low temperature	4 h at -40°C ASTM D2671	Non-cracking
Water absorption	ISO 62	0,5% max after 24 h at 23°C

# Self-sealing termination



Product	LV cable conductor (mm <sup>2</sup> )		D1 (mm)	d1 (mm)	S1 ±20% (mm)	D2 (mm)	d2 (mm)	S2 ±20% (mm)	L1 ±10% (mm)	L2 ±10% (mm)
	from	to								
RayK333	4	16	22	8	2	9	3,5	2	55	18
RayK224	25	70	40	16	2	15	7,5	2	125	35
RayK466	95	185	60	23	2,5	25	7,5	2,5	155	45



Product	LV cable conductor (mm <sup>2</sup> )		D1 (mm)	d1 (mm)	S1 ±20% (mm)	D2 (mm)	d2 (mm)	S2 ±20% (mm)	L1 ±10% (mm)	L2 ±10% (mm)
	from	to								
RayW533	4	35	38	17	2,7	14	4,5	2,5	98	23
RayW516	50	150	60	25	3	25	8	2,5	165	50
RayW526	185	300	80	38	3,5	35	11	3,5	185	55
RayW248	185	500	110	50	4,0	46	17,5	3,5	250	65



Product	LV cable conductor (mm <sup>2</sup> )		D1 (mm)	d1 (mm)	S1 ±20% (mm)	D2 (mm)	d2 (mm)	S2 ±20% (mm)	L1 ±10% (mm)	L2 ±10% (mm)
	from	to								
RayK033	4	35	42	15	2,3	14	3,5	1,9	105	26
RayK046	50	70	55	21	3,1	20	5	2,5	150	40
RayK016	95	150	65	26	3,5	26	7	2,9	175	45
RayK026	185	300	102	47	3,9	38	12	3	198	58

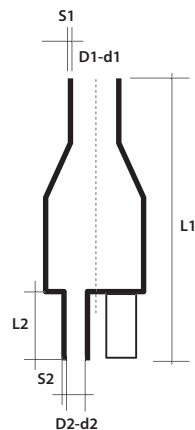

D = Ø min. before shrinkage  
d = Ø max. after free shrinkage  
S1 / S2 = min. rated size after free shrinkage  
L1 / L2 = min. rated size after free shrinkage



**HF** Halogen Free

Tensile resistance	ISO 37	10,5 MPa (min)
Elongation	ISO 37	300 % (min)
Density	ISO 1183	10-1,3 g/cm <sup>3</sup>
Hardness	ISO 868	50-70 Shore D
Accelerated ageing (7 days at 150°C) ISO 188	Tensile resistance ISO 37	8,5 Mpa (min)
	Ultimate elongation ISO 37	100% (min)
Flexibility at low temperature	4 h at -40°C ASTM D2671	Non-cracking
Water absorption	ISO 62	0,5% max after 14 days at 23°C



# Insulation tapes

## SELF-ADHESIVE TAPES IN PVC



**Rayteam**  
Self-adhesive for general use



**Raytech Super 3-3**  
Self-adhesive for low and high temperatures

**Raytech 2-2**  
Heavy duty self-adhesive

## SELF-AMALGAMATING



**Raytech 2.3**  
Insulation tape EPR

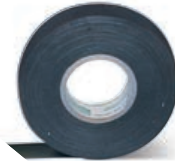

**Raytech 23 BT**  
LV insulation tape

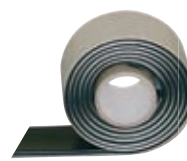

**Raytefill**  
Heavy duty insulation tape



**Raytech 7-0**  
Silicone insulation tape

## SPECIAL TAPES



**MCA-FV**  
Fibreglass self-adhesive tape



**Raycopper**  
Copper braid tape

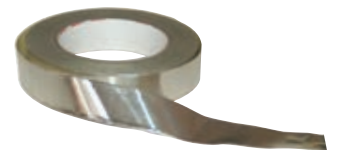

**MCA-ALL**  
Self-adhesive aluminium tape





# Rayteam

Self-adhesive for general use.

PVC adhesive tape for electrical applications and mechanical protection for general use. Recommended for insulating low-voltage joints and for covering cables, accessories and products in general. It is self-extinguishing and does not propagate fire. Excellent resistance to ageing, exposure to weather conditions, hydrocarbons and chemical solvents in general.

## 0,13 mm

Product	Width	Thickness	Length
Rayteam 1925/13	19 mm	0,13 mm	25 m
Rayteam 1510/13	15 mm	0,13 mm	10 m

## 0,15 mm

Rayteam 1925	19 mm	0,15 mm	25 m
Rayteam 1510	15 mm	0,15 mm	10 m
Rayteam 2525*	25 mm	0,15 mm	25 m
Rayteam 1525	15 mm	0,15 mm	25 m



Available colours: black, grey, white, red, blue, brown, yellow/green.

\* only black, white and grey. Contact Raytech for other sizes and thicknesses.

Property	Test method	Typical values
Breaking Strength (tensile)	ASTM-D-1000	65N/25 mm width min
Elongation at break	ASTM-D-1000	> 200 %
Adhesion to steel	ASTM-D-1000	6 N/25 mm width
Adhesion to backing	ASTM-D-1000	6 N/25 mm width
Self-extinguishing	ASTM-D-1000	self ext. 4 max
Operating temperature	UL 510	-5°C / 85°C
Electric strength after exposure to damp environment	ASTM-D-1000	40 kV/mm min



## Approvals

### Complies with standards

UL 510 • CEI 15-15  
CEI 60454 (EN60454)

### VDE marking



**Approvals**

UL 510  
 CSA 22.2  
 ASTM-D-3005  
 HH-I-595C  
 CEI15-15  
 CEI 60454 (EN60454)

## Raytech Super 3-3

Self-adhesive for use at low and high temperatures.

PVC adhesive tape with excellent electrical and mechanical properties for a wide range of working temperatures. This tape is particularly suitable for use at low temperatures and in all weather conditions, including the most extreme. The tape is flame retardant and self-extinguishing. It is recommended as the primary insulation for joints up to 0.6/1 kV, and as the outer covering for joints and other products, and for all applications at low temperatures.

Product	Colour	Width	Thickness	Length
Raytech Super 3-3	●	19 mm	0,18 mm	20 m

Property	Test method	Typical values
Breaking Strength (tensile)	ASTM-D-1000	80N/25 mm width min
Elongation at break	ASTM-D-1000	240% min
Adhesion to steel	ASTM-D-1000	>7 N/25 mm width
Adhesion to backing	ASTM-D-1000	>7 N/25 mm width
Adhesion to backing at -7°C	ASTM-D-1000	>18 N/25 mm width
Self-extinguishing	ASTM-D-1000	self ext. 4 max
Operating temperature	CSA-22.2	-18°C / 105°C
Electric Strength after exposure to damp environment	ASTM-D-1000	51 kV/mm min

**Approvals**

UL 510  
 CSA 22.2  
 ASTM-D-2301  
 MIL-I-7798A  
 CEI 15-15  
 CEI 60454 (EN60454)

## Raytech 2-2

Heavy duty thickness auto-adhesive.

PVC adhesive tape for electrical and mechanical purposes even in the most severe conditions (0.25 mm. thick). Particularly suitable for insulating and protecting cables, accessories and other products against adverse weather conditions and industrial solvents, and as a primary low voltage joint insulation. It is self-extinguishing and non flame-propagating. It has excellent wear resistance, even when it is installed and working under very severe conditions.

Product	Colour	Width	Thickness	Length
Raytech Super 2-2	●	19 mm	0,25 mm	20 m

Property	Test method	Typical values
Breaking Strength (tensile)	ASTM-D-1000	125N/25 mm width min
Elongation at break	ASTM-D-1000	>200 %
Adhesion to steel	ASTM-D-1000	>6 N/25 mm width
Adhesion to backing	ASTM-D-1000	>6 N/25 mm width
Self-extinguishing	ASTM-D-1000	self ext. 4 max
Working temperature maximum	CSA-22.2	105°C
Operating temperature	UL 510	-10°C
Electric strength after exposure to damp environment	ASTM-D-1000	40 kV/mm min

## Raytech 2.3

EPR Self-amalgamating low and high voltage tape.

This ethylene-propylene (EPR) self-amalgamating tape is used for insulating and sealing high voltage electrical joints for voltages up to Um 72 kV. It amalgamates rapidly, adapting itself to the product underneath, forming a solid unit without air bubbles. It is particularly resistant to partial discharges (corona), with the characteristics remaining unchanged with time. Joints must be protected with a PVC tape or similar.

Product	Colour	Width	Thickness	Length
Raytech 2.3	●	19 mm	0,76 mm	9 m

Property	Test method	Typical values
Breaking Strength (tensile)	ASTM-D-4325	2.8 MPa min
Elongation at break	ASTM-D-4325	800% min
Amalgamation ability	ASTM-D-4325	2,0 mm
Overload temperature	ASTM-D-4388	130°C
Operating temperature	ASTM-D-4388	90°C
Dielectric strength	ASTM-D-4325	35 kV/mm min
Relative dielectric constant	ASTM-D-4325	2.7
Volume resistivity	ASTM-D-4325	10 <sup>15</sup> Ω cm min
Resistance to ozone	ASTM-D-4325	Positive
Resistance to U.V.	ASTM-D-4325	Positive



### Approvals

ASTM-D-4388  
HH-I-553C/Grade A  
MIL-I-3825 B

## Raytech 23 BT

Low voltage Self-amalgamating tape.

This rubber self-amalgamating low voltage tape (0.6/1 kV) is used for insulating and sealing low voltage electrical joints. It amalgamates rapidly, adapting itself to the product underneath, forming a solid unit. The joints must be protected with a PVC tape. The characteristics remain unchanged with time.

Product	Colour	Width	Thickness	Length
Raytech 23 BT	●	19 mm	0,76 mm	6,7 m

Property	Test method	Typical values
Breaking Strength (tensile)	ASTM-D-4325	1.8 MPa min
Elongation at break	ASTM-D-4325	300 % min
Amalgamation ability	ASTM-D-4325	2,0 mm
Overload temperature	ASTM-D-4388	100°C
Operating temperature	ASTM-D-4388	90°C
Dielectric strength	ASTM-D-4325	20 kV/mm min



### Approvals

UL 510



Approvals  
MIL-I-17695 A

## Raytefill

Thick low voltage Self-amalgamating tape.

This self-amalgamating thick-wall (3.2mm) has been specially designed for the rapid reconstruction of low-voltage cable insulation, to cover complex shapes (insulating and covering joints between busbars and relative bolts, clamps, etc.) and to seal against possible penetration of humidity. Once applied it becomes a solid, absolutely non-porous mass, with first class electrical qualities and ageing resistance, perfectly suited to the product it is covering.

Product	Colour	Width	Thickness	Length
Raytefill	●	38 mm	3,2 mm	1,5 m

Property	Test method	Typical values
Ultimate elongation	ASTM-D-4325	>1000 %
Amalgamation ability	ASTM-D-4325	2,0 mm
Operating temperature: Continuous	ASTM-D-4388	90°C
Operating temperature: Overload	ASTM-D-4388	95°C
Dielectric strength	ASTM-D-4325	23,0 kV/mm



Approvals  
ASTM-D-2148  
MIL-I-46852A

## Raytech 7-0

Self-amalgamating silicone rubber tape.

This self-amalgamating silicone rubber tape is used for covering medium and high voltage terminations on extruded cables up to Um 72 kV, because of its first-rate performance for electrical installations in damp or polluted environments, against corrosion, corona and against ageing. It is used as an insulation up to 180°C due to its excellent heat properties. It can be perfectly adapted to all the shapes to be covered.

Product	Colour	Width	Thickness	Length
Raytech 7-0	●	25 mm	0,51 mm	9,1 m

Property	Test method	Typical values
Elongation at break	ASTM-D-1000	>500%
Resistance to U.V.	ASTM-D-4325	Positive
Resistance to ozone	ASTM-D-4325	Positive
Working temperature maximum	ASTM-D-4388	180°C
Dielectric strength	ASTM-D-4325	>35 kV/mm



## Raycopper

Tinned copper mesh tape for electrical screening.

Product	Colour	Width	Thickness	Length
Raycopper 1000	Silver	60 mm	0,3 mm	1 m
Raycopper 2000	Silver	60 mm	0,3 mm	2 m
Raycopper 3000	Silver	60 mm	0,3 mm	3 m
Raycopper 5000	Silver	60 mm	0,3 mm	5 m
Raycopper 6000	Silver	60 mm	0,3 mm	6 m

Property	Typical values
Material	Tinned copper mesh tape with high flexibility
Elongation at break	70% min
Breaking Strength (tensile)	35 N/10 mm
Volume resistivity	0,3 cm



## MCA-FV

Fiberglass adhesive tape.

Self-adhesive mono-directional fibreglass tape with polypropylene support. Suitable for cable fixing on pipes (i.e.: Raytech MCA... cables for electrical tracing), and for any kind of strong fixing. Inextensible, it is suitable for temperatures up to 130°C.

Product	Colour	Width	Thickness	Length
MCA-FV	White	12 mm	0,13 mm	50 m

Property	Test method	Typical values
Breaking Strength (tensile)	AFERA 4004	130 N/cm min
Ultimate elongation	AFERA 4005	5%
Adhesion to steel	AFERA 4001	4 N/cm min
Adhesion to backing	AFERA 4001	3 N/cm min

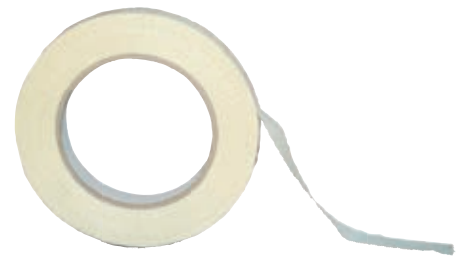

## MCA-ALL

Self-adhesive aluminium tape.

Self-adhesive adhesive aluminium tape suitable for fixing on flat surfaces (i.e.: for heating cable fixing on tanks outer surfaces); used also for holes or abrasion repairs on metallic or plastic surfaces. Strong adhesion.

Product	Colour	Width	Thickness	Length
MCA-ALL 75	Aluminium	75 mm	0,06 mm	50 m

Property	Typical values
Breaking Strength (tensile)	1,2 da N/cm min
Elongation at break	5% min
Adhesion to steel	4 N/cm min
Adhesion to backing	4,5 N/cm min
Flame resistance BS476-7	Class 1





# CABLE PULLERS and LUBRICANTS

## Speedy Line

Raytech, leader in the field of cable accessories, has always based its research and product line on the quality. This is why, also in the field of the pulling tapes and lubricants, it is today offering systems of extremely high reliability and quality, always over the conventional types offered by the market:

- These fixed head, interchangeable nylon fishtapes are constructed with very high mechanical characteristic, long-lasting materials. Speedy Sonda tapes are made of PERLON, a practically non-deformable nylon, protecting the installer from unexpected elongation or breakage of the probe in ducts.
- "Twisted" polyester tapes, self-lubricated, extremely flexible and light, with exceptional mechanical characteristics, able to be inserted into long cable ducts, avoid the need of intermediate cable boxes; allowable bending radius is very small and, once bent, they do not break and released they come back to their original shape.
- Fibreglass tapes, thanks to their "nervous" elasticity together with their strength, are easy to use in any type of conduit.
- Nylon-steel tapes, when an exceptional strength is required.
- The widest range of accessories for all the types.
- Raytech offers the widest range of high sliding, non-toxic lubricants that are easily removable from cables. Choose from lubricant oil, lubricant gel (non-drip, allowing for a savings of up to 3 times compared to conventional types) or lubricant spray (easy application directly into the cable ducts, non-drip and dramatically reducing friction and traction force).



### Characteristics

Product	Positioning	Ease of bending	Pulling resistance
Speedy Nylon and Speedy Sonda	Good	Good	Very good
Polyester Speedy Helix	Very good	Very good	Very good
Fibreglass Speedy Glass	Excellent	Good	Good
Nylon-Steel Speedy Steel	Very good	Excellent	Excellent

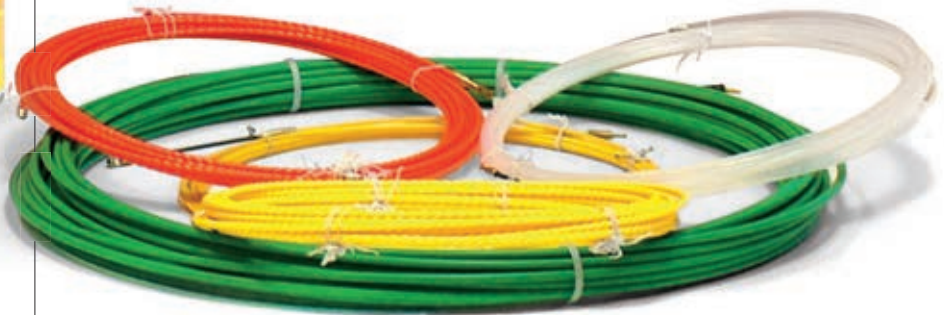

**Speedy Nylon**  
Fixed head Nylon probes

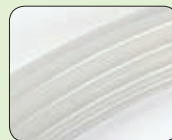

**Speedy Sonda 3**  
Fixed head or interchangeable Nylon Perlon® Ø 3 mm

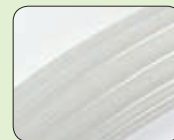

**Speedy Sonda 4**  
Fixed head or interchangeable Nylon Perlon® Ø 4 mm

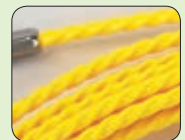

**Speedy Helix 5**  
Polyester Ø 5 mm with eyelet and fixed flexible head

## Speedy Wire Oil - Speedy Wire Gel - Speedy Wire Spray

Lubricants for threading any kind of cable, power, telecom and optical fibre in ducts, smooth or corrugated piping, etc. With a very high lubrication power, especially when compared to products for similar uses, these are easily removable from cables, and require very low installation strength, even in the case of bent conduits.

**Speedy Wire Oil** is a standard, fluid and low viscosity lubricant.

**Speedy Wire Gel**, thanks to its consistency, allows for savings of up to 3 times the amount used compared to other solutions.

**Speedy Wire Spray**, thanks to its canister and dispensing nozzle, allows for suitable guiding of the lubricant, including inside piping and ducts, greatly facilitating application.



Product	Package	Wrapping	Appearance	PH	Density
Speedy Wire Oil	1 L bottle	12-piece pack	Transparent gel	6 - 8	About 1
Speedy Wire Gel	1 L bottle	12-piece pack	Milky liquid	6 - 8	About 1
Speedy Wire Spray	400 ml canister	12-piece pack	White foam	8,5 - 9	About 1,04

## Speedy Nylon

Fixed head Nylon transparent cable pullers.

Product	Ø (mm)	Length (m)	Package
Speedy Nylon 3/5-F	3	5	50
Speedy Nylon 3/10-F	3	10	40
Speedy Nylon 3/15-F	3	15	30
Speedy Nylon 3/20-F	3	20	20
Speedy Nylon 3/25-F	3	25	15
Speedy Nylon 4/5-F	4	5	50
Speedy Nylon 4/10-F	4	10	25
Speedy Nylon 4/15-F	4	15	20
Speedy Nylon 4/20-F	4	20	15
Speedy Nylon 4/25-F	4	25	12

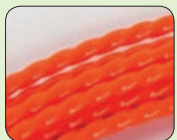
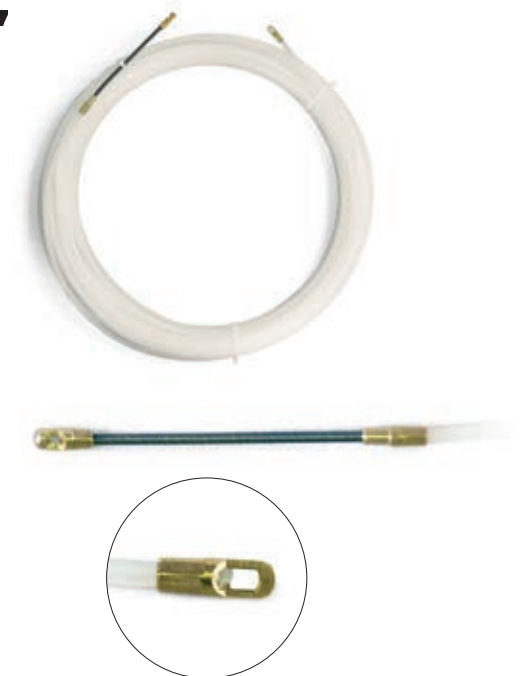

**Speedy Helix 4**  
Polyester Ø 4 mm  
with eyelet and fixed  
flexible head

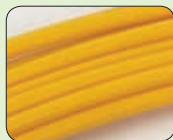

**Speedy Glass**  
Interchangeable  
head fibreglass  
probe Ø 3 mm



**Speedy Steel**  
Nylon-steel  
probe Ø 6 mm



**Accessories**



## Speedy Sonda 3

Nylon tape PERLON® Ø 3 mm with fixed or interchangeable head\*.

Fixed head				
Product	Colour	Ø (mm)	Length (m)	Item packaging
Speedy Sonda 3/5 -F	Transparent	3	5	50
Speedy Sonda 3/10 -F		3	10	40
Speedy Sonda 3/15 -F		3	15	30
Speedy Sonda 3/20 -F		3	20	20

Interc. head				
Product	Colour	Ø (mm)	Length (m)	Item packaging
Speedy Sonda 3/5 -I	Transparent	3	5	50
Speedy Sonda 3/10 -I		3	10	40
Speedy Sonda 3/15 -I		3	15	30
Speedy Sonda 3/20 -I		3	20	20

Other dimensions available on request

\* Supplied with flexible head curve guide and pulling eyelet



## Speedy Sonda 4

Nylon tape PERLON® Ø 4 mm with fixed or interchangeable head\*.

Fixed head				
Product	Colour	Ø (mm)	Length (m)	Item packaging
Speedy Sonda 4/5 -F	Transparent	4	5	35
Speedy Sonda 4/10 -F		4	10	25
Speedy Sonda 4/15 -F		4	15	20
Speedy Sonda 4/20 -F	Black **	4	20	18
Speedy Sonda 4/25 -F		4	25	15

Interc. head				
Product	Colour	Ø (mm)	Length (m)	Item packaging
Speedy Sonda 4/5 -I	Transparent	4	5	35
Speedy Sonda 4/10 -I		4	10	25
Speedy Sonda 4/15 -I		4	15	20
Speedy Sonda 4/20 -I	Black **	4	20	18
Speedy Sonda 4/25 -I		4	25	15

Other dimensions available on request

\* Supplied with flexible head curve guide and pulling eyelet

\*\* For the colour black **add N** to the code



## Speedy Helix 5

Polyester tape Ø 5 mm with fixed eyelet and flexible interchangeable head.

Twisted tapes, very strong, extremely flexible and light. They pass the "4 curves test" on both rigid and corrugated pipes, but they can also avoid to have an intermediate box, and even if bent on themselves they do not break.

Product	Colour	Ø (mm)	Length (m)	Item packaging
Speedy Helix 5/10	 Yellow	5	10	1
Speedy Helix 5/15		5	15	1
Speedy Helix 5/20		5	20	1
Speedy Helix 5/25		5	25	1
Speedy Helix 5/30		5	30	1
Speedy Helix 5/50		5	50	1
Speedy Helix 5/60		5	60	1

Other dimensions available on request

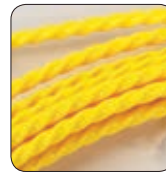

## Speedy Helix 4

Polyester tape Ø 4 mm with interchangeable eyelet and head\*.

Twisted tapes, very strong, extremely flexible and light. They pass the "4 curves test" on both rigid and corrugated pipes, but they can also avoid to have an intermediate box, and even if bent on themselves they do not break.

Product	Colour	Ø (mm)	Length (m)	Item packaging
Speedy Helix 4/10	 Orange	4	10	1
Speedy Helix 4/15		4	15	1
Speedy Helix 4/20		4	20	1
Speedy Helix 4/30		4	30	1

Other dimensions available on request

\* Supplied with flexible head curve guide and pulling eyelet





The tape is complete of repairing kit

## Speedy Glass

Interchangeable head “self-starting”  
fibreglass Ø 3 mm cable pullers\*.

Suitable for light use, even on long lengths, easy to use thanks to their “nervous” elasticity which makes easier their positioning in pipes and conduits.

Interc. head				
Product	Colour	Ø (mm)	Length (m)	Item packaging
Speedy Glass 3/10	 Yellow	3	10	10
Speedy Glass 3/15		3	15	10
Speedy Glass 3/20		3	20	10
Speedy Glass 3/25		3	25	10
Speedy Glass 3/30		3	30	10

Other dimensions available on request

\* Supplied with flexible head curve guide and pulling eyelet



## Speedy Steel

Nylon-steel tape Ø 6 mm complete of all accessories.







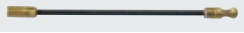

Nylon-steel tapes are extremely robust, and are made of an internal core 4 x 1,5 mm steel made, coated with a nylon layer. Particularly suitable for industrial use with heavy duty. Use in installations without voltage.

Product	Colour	Ø (mm)	Length (m)	Item packaging
Speedy Steel 6/20	 Green	6	20	1
Speedy Steel 6/25		6	25	1
Speedy Steel 6/30		6	30	1
Speedy Steel 6/40		6	40	1
Speedy Steel 6/50		6	50	1
Speedy Steel 6/60		6	60	1









Other dimensions available on request

## Accessories

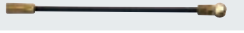



For Speedy Sonda and Speedy Helix cable pullers.

Product	Description	Item packaging	
Speedy TFG	Flexible head curve guide	3	
Speedy TFC	Flexible head with sheave	3	
Speedy OTL	Long pulling eyelet	3	
Speedy OTC	Short pulling eyelet	3	
Speedy BU	Joint bush for fishtapes	3	
Speedy PN	Pin M4 (for tape Ø 4 mm)	3	
Speedy AT	Pulling slot	3	
Speedy CA	Accessories kit	1	

For Speedy Glass cable pullers.

Product	Description	Item packaging	
Speedy REP	Repairing kit	3	
Speedy TFG	Flexible head curve guide	3	
Speedy TFC	Flexible head with sheave	3	
Speedy OTL	Long pulling eyelet	3	
Speedy OTC	Short pulling eyelet	3	
Speedy BU	Joint bush for fishtapes	3	
Speedy PNG	Pin for Speedy Glass tape	3	
Speedy AT	Pulling slot	3	
Speedy CA	Accessories kit	1	

For Speedy Steel cable pullers.

Product	Description	Item packaging	
Speedy MO	Snap link	3	
Speedy TS	Flexible head curve guide	3	
Speedy OL	Clamping device	3	
Speedy RS	Sliding wheel device	3	

Available upon request.

Product	Description	Item packaging	Image
Speedy AS	Reels with support	1	(see A)
Speedy AF	Reels on frame	1	(see B)
Speedy AFS	Steel reels on frame	1	(see C)
Speedy PR Glass	Repairing pliers for Speedy Glass tapes	1	(see D)



(A)



(B)



(C)



(D)



# FIRE STOP BARRIERS



**Fire Stop Bag**  
Fire stop barrier using  
intumescent bags

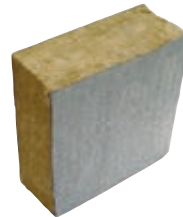

**Fire Stop Panel**  
Fire stop barrier panels



**Fire Stop Collar**  
Fire stop pipe transit  
collar for plastic pipes



**FSC-TPC**  
Fire stop barrier for  
plastic and/or  
corrugated pipes  
with cables



**FSM**  
Fire stop barriers  
using incombustible  
plaster

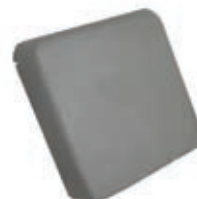

**FSCP**  
Fire stop cover for  
fluorescent fittings



**FSCF**  
Fire stop cover  
for spot lights



### Fire Stop Tape

Fire stop barrier in an intumescent tape for plastic corrugated pipes



### Fire Stop Seal

Fire stop barrier with intumescent sealing mastic



### Fire Stop Foam

Fire stop barrier expanding foam

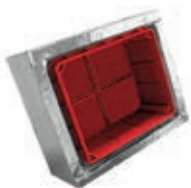

### FSCC

Fire stop cover for boxes



### FSSE

Intumescent fire stop barrier for electrical boxes



### FSCOT110

Metal pipe insulating mat protective barrier





### Approval

**Class** EI 120

Non toxic and asbestos free

In compliance with standard  
EN 1366-3

## Fire Stop Bag

Fire stop barrier in an intumescent bag.

Intumescent incombustible bags which stop the passage of fire through openings in walls. They are available in different sizes and they have to be placed to seal the openings, both in walls and floor slabs. At a temperature of 200°C the material starts to compact sealing the gaps thus avoiding the passage of the flames.

- Made from a fireproof fabric
- Contains intumescent putty seal inside

Product	Bag dimensions (mm)
FSB-11	250 x 100 x 25
FSB-12	250 x 200 x 35
FSB-13	250 x 300 x 35

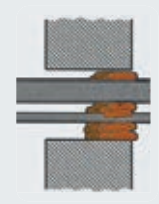

**INSTALLATION**  
Finish and opening then lay the bags as bricks, staggered and overlapped.

For the application on plasterboard walls please contact Raytech.

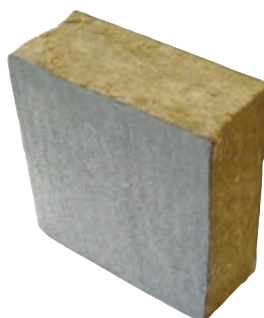

### Approval

**Class** EI 120

Non toxic, asbestos and solvent free

In compliance with standard  
EN 1366-3

## Fire Stop Panel

Fire stop barriers in panels.

Incombustible panels treated on the surface with putty to stop the passage of fire through openings in walls. This product allows for the sealing of cavities in walls safely and cost effectively.

- Manufactured from Rockwool
- Coated with putty
- Resistant to mould and bacteria

Product	Dimension (mm)
FSP-11	600 x 600 x 51



**INSTALLATION**  
Finish and clean the opening edges then cut the panels with a cutters and position them in the opening. The edges and the jointing lines, as well as the interstices among the cables, are sealed and covered with FIRE STOP SEAL FSS sealant.

For the application on plasterboard walls please contact Raytech.



## Fire Stop Collar

Fire stop transit collar for plastic pipes.

Fire stop barrier transit collar for plastic pipes (minimum wall thickness 200mm). Available in a wide range of dimensions to surround pipes that pass through walls.

- Stainless steel outer band
- Contains intumescent putty seal inside

Product	Ø (mm)
FSC 11	from 63 to 110
FSC 12	from 110 to 160
FSC 13	200
FSC 14	250

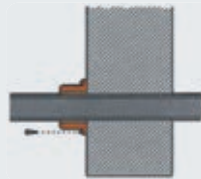

### INSTALLATION

No special care is required: the collar, when opened, is positioned around the duct, closed and fastened by means of inserts

For other dimensions and installation please contact Raytech.



### Approval

**Class** EI 120  
Non toxic and asbestos free

In compliance with standard EN 1366-3

## Fire Stop Tape

Fire stop barrier in an intumescent tape for plastic corrugated pipes.

Fire stop barrier in an intumescent tape for the crossing closure of single corrugated pipes. Highly heat-sensitive, intumescent graphite tape with high expansion properties for the protection of corrugated electrical pipes containing cables. Applied on both sides of the pipe crossing through the wall so as to surround the pipe. The heat from a fire causes the tape to expand and fill all possible voids.

Product	Application corrugated pipe diameter range (mm)	Width (mm)	Thickness (mm)	Length (m)
FST-E-25/32	from 25 to 32 *	20	2	10

\*containing cables up to 10 mm<sup>2</sup>

### RECOMMENDATION

The solution is 10m long, and it can be cut at the required length, saving the remaining parts for a future application. Can also be used in conjunction with FSCI, FSSE, FSCC box covering protections.

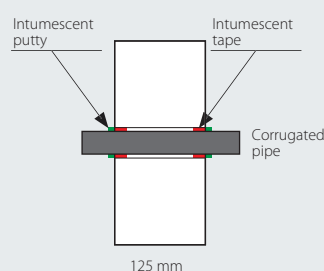

### INSTALLATION

Wrap the tape twice around the corrugation, on both sides of the wall, fitting it in the through hole. Seal with FIRE STOP SEAL (FSS) sealant putty. Let dry.



### Approval

**Class** EI 120  
Non toxic and asbestos free

In compliance with standard EN 1366-3



### Approval

**Class EI 120**  
Non toxic and asbestos free  
Does not emit toxic gases  
and dense fumes

In compliance with standard  
EN 1366-3

## Fire Stop Seal

Fire stop barrier in intumescent sealing mastic.

Intumescent mastic to seal and close small voids in walls, also in addition to other types of barriers. It is applied to seal a void or to provide a barrier in a cable duct.

- A polymer compound with fireproof fibres and intumescent in an aqueous solution
- Non-hygroscopic and thixotropic
- Can be applied with a spatula

Product	Package
FSS 310	0,3 kg cartridge
FSS 10	Spatula type, 10 kg drum

**INSTALLATION**  
Once the edges of the opening have been finished and cleaned, the sealant putty is put in place with a spatula in the case of boxed product, or with a spatula or silicone gun for cartridge product.

For other dimensions or the application on plasterboard walls please contact Raytech.

## Intumescent sealant putty for corrugated pipes.

Putty containing highly heat-sensitive graphite, specifically for corrugated electrical pipes containing cables. Crossing can contain up to two 25mm corrugated pipes paired in the same hole with cable with cross-section up to 10mm<sup>2</sup>.

Product	Package
FSS-E-300	0,3 lt cartridge

**INSTALLATION**  
The putty must be applied on both sides of the piping crossing through the wall.



### Approval

**Class EI 120**  
Non toxic and asbestos free  
Does not emit toxic gases  
and dense fumes

In compliance with standard  
EN 1366-3

## Fire Stop Foam

Fire stop barriers in expanding foam.

Single-component expandable sealant foam for filling and fire sealing of small crossing gates on cable duct channels that have been previously compartmented with FSB bags and small gaps. Each canister covers a volume of approximately 20 L.

- Made from a fire resistant polyurethane based foam
- Graphite fortified
- Hardens upon contact with air
- Suitable for the protection of plasterboard walls or slabs

Product	Package
FSF 700	Spray can of 750 ml

**INSTALLATION**  
After the edges of the openings have been cleaned, shake the can for at least 30 seconds, then turn upside down and spray the product.





## FSC-TPC

Fire stop barrier for plastic and/or corrugated pipes with cables.

Protection designed to be built into the wall after pipes have been installed. Can be installed in locations where the construction support is damaged and there is an annular space around the services. It is possible to protect mixed corrugated plastic pipes in the same crossing.

- For PE/PP, PVC, Abs pipes containing electrical cables or other services
- Pipes can be grouped and protected in bundles

Product	For pipes with diameter (mm)
FSC-TPC 050	50
FSC-TPC 060	60
FSC-TPC 090	90
FSC-TPC 120	125

### INSTALLATION

Clean the pipe. Open the sleeve longitudinally, place it around the pipe and clamp it on it using special metal tabs. Push the collar towards the centre of the wall.

Fix with FSS putty in the event of installation on a special crossover pipe.

Contact Raytech regarding through openings or installation on inclined piping.



Approval

**Class** EI 120

Non toxic and asbestos free  
Does not emit toxic gases  
and dense fumes

In compliance with standard  
EN 1366-3

## FSM

Fire stop barriers in incombustible plaster.

Protective coating to seal and prevent fire propagation in wall cavities; it can be applied manually or sprayed. It can be easily mixed in big quantities with suitable mixer (e.g. concrete mixer).

- Made from mineral fibres
- Simply mix with water and with or without cement mixes
- For gates on walls or slabs

Product	Package
FSM 20	20 kg bag

### INSTALLATION

After the edges of the openings have been finished and cleaned, the incombustible plaster is mixed with water, than applied manually, with a trowel or a pump, and left to dry in air. Water quantity: about 0,85 lt/kg (volume 1 kg = about 2,5 dm<sup>3</sup>).

For other applications please contact Raytech.



Approval

**Class** EI 120

Non toxic and asbestos free  
Does not emit toxic gases  
and dense fumes

In compliance with standard  
EN 1366-3

## FSCP

Fire stop barriers for ceiling lights.

Fireproof barriers for fluorescent lights in suspended ceilings. Maintains conditions of fire resistance of ceilings and suspended ceilings. Slightly reduces the temperature in the space between the ceiling and the ceiling panel.

- Made from non-toxic mineral fibres
- Prevents propagation
- Flexible, light and self-supporting, easy to install and to remove

Product	Dimension (mm)	Weight (kg)
FSCP 600	720 x 750 x 150	1,7 about
FSCP 1200	1330 x 720 x 140	3,5 about

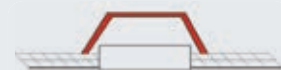

### INSTALLATION

No special care is required. The protection must be placed on the ceiling light grid adhering to the panel.



Approval

**Class** EI 120

Non toxic and in compliance with standard  
EN 1365-2 • 1363-1

**Ray  
tech**



### FSCF

Fire stop hoods for downlighters.

Fireproof dome shaped hood for downlighters in suspended ceilings. Maintains conditions of fire resistance of ceilings and suspended ceilings. Prevents fire propagation and slightly reduces the temperature in the void between the ceiling and the suspended ceiling.



Approval

Class EI 120

Non toxic

It expands up to 5 times

In compliance with standard EN 1365-2 • 1363-1

- Made from non-toxic mineral fibres
- Resistant to fire and expandable compounds
- Prevents lamp overheating
- Flexible, light and self-supporting
- Easy to install and to remove

Product	Dimension (mm)	Type
FSCF 250	250 x 280	Cone-shaped
FSCF 350	350 x 230	Dome-shaped

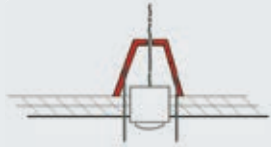

**INSTALLATION**  
No special care is required. The protection must be placed on the spotlight, adhering to the panel.

For other dimensions please contact Raytech.

### FSSE

Intumescent fire stop barrier for electrical boxes.

Intumescent barrier for the fire protection of electrical system components built into walls.



Approval

Class EI 120

Non toxic

In compliance with standard EN 1364-1

- Inserted in electrical boxes
- Protection with high expansion properties
- Guarantees wall conditions in the event of a fire

Product	For electric boxes
FSSE 01	Up to three modules (type 503)
FSSE 02	Up to six modules (type 506)

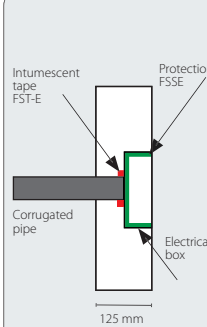

**INSTALLATION**  
The protections are inserted inside the box before the insertion of modules. Protect corrugated pipes crossing walls with FST-E-25/32



## FSCC

Fire stop barriers for covering enclosures.

Fire protection system for electrical enclosures and junction boxes. These protect plaster-board wall compartments from heat and fire propagation.

- Made from calcium silicate
- Contains enclosure

Product	External dimension (mm)	Internal dimension (mm)
FSCC 150	150 x 120 x 75	110 x 80 x 55

### INSTALLATION

After the opening edges have been finished and cleaned, the protection is properly placed and fixed to the wall by means of screws and putty.



### Approval

#### Class EI 120

Non toxic and asbestos free  
Does not emit toxic gases and dense fumes

In compliance with standard EN 1364-1

## FSCO T110

Metal pipe insulating mat protective barrier.

The FSCO T110 barrier is made up a flexible and easily conformable, highly fire resistant insulating mat. It is clad with an aluminium sheet and protects insulated or non-insulated metal piping in wall crossings. The product is cut and modelled with ease, wrapped in a single layer around the pipe, and then closed with aluminised tape. Protects metal piping crossing walls or slabs, preventing longitudinal transmission of heat and fusion of any insulating material.

- Composed of fibres free of any resins or organic binders
- For wall thicknesses of at least 125 mm

Product	Colour	Width	Thickness	Length
FSCO T110	Aluminium	1 m	20 mm	5 m

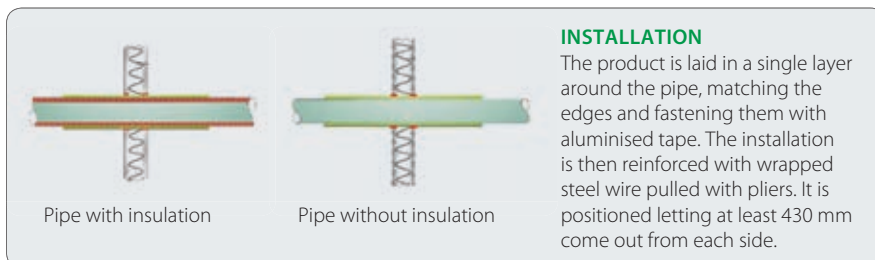

### INSTALLATION

The product is laid in a single layer around the pipe, matching the edges and fastening them with aluminised tape. The installation is then reinforced with wrapped steel wire pulled with pliers. It is positioned letting at least 430 mm come out from each side.



### Approval

#### Class EI 120

Non toxic and asbestos free

In compliance with standard EN 1366-1 • EN 1366-3 • EN 1366-5



# SPECIALS

## Galactic Line

KITS FOR THE CONNECTION, MAINTENANCE AND PROTECTION OF ELECTRICAL SYSTEMS



Galactic Mammut Security  
Straight joint pre-filled with gel



Galactic Protection  
Bicomponent rubber for printed circuit protection against animal intrusion



Galactic Animal Barrier  
Mouldable rubber paste to prevent animal intrusion



Galactic Water Stop  
Ready to use single component gel for generic use

## Rubber Line



Ray RTV  
Fast cross linking bicomponent silicone rubber



Gasket Kit  
Kit for the packaging of rubber profiles



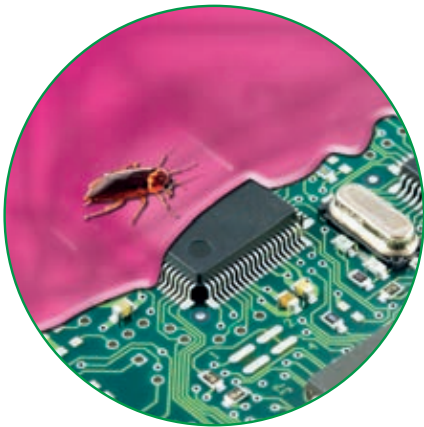

**Galactic Nano Joint**  
Straight and derived single pole joint complete with pre-filled gel snap connector



**Galactic Separator**  
Spacer and connector kit



**Galactic Cleaner Professional**  
Extraordinary detergent for all types of use

# Indispensable



**Shiny Solar**  
Solution for solar and photovoltaic panel maintenance



Clamps



Clamp accessories







# Galactic Mammut Security

Straight joint pre-filled with gel.

Galactic Mammut Security is an extremely compact accessory that is suitable for resolving insulation and sealing problems. Make reliable strip connector connections using the components found within the kit. Supplied with connectors for up to 3 core 4mm cables. Suitable for all types of domestic and industrial uses. Make safe temporary or uninsulated connections already in place. For quick repairs of damaged cable and extension cords. Suitable for outdoor use, in panels, within the kitchen etc. Non-toxic, no shelf life, easily re-enterable. Once closed the internal connectors are immediately protected. Galactic Mammut is essential in any area where water is present.



- No more tangled wires or uncovered connectors!
- A safe, reliable and quick solution

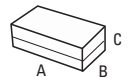

Product	Cable formation	Dimension A x B x C (mm)
Galactic Mammut Security	Cables 3 x 1 to 4 mm <sup>2</sup> 3 insulated conductors with ground from 1 to 4 mm <sup>2</sup>	61 x 35 x 28

**Package:**  
3-piece blister pack

**Electrical performance:**  
CEI EN 50393 as applicable  
(testing under water head  
of the accessory installed in a box)

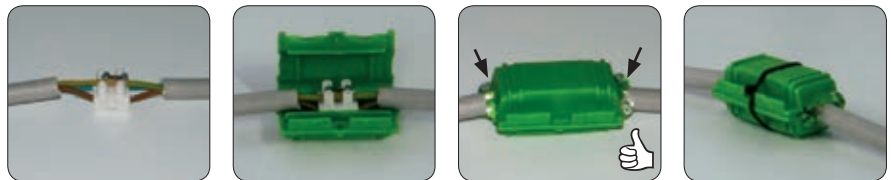

## BEFORE



## AFTER



# Galactic Protection

Bicomponent rubber for printed circuit protection including against animal intrusion.

Protection for printed circuits which are especially exposed to dust, animal intrusion (insects, snails, snakes, etc., e.g. in automatic gate trays). Opaque but slightly translucent allows cover forming a protective film. It can be removed (adheres without sticking) even on a small area to access the underlying component. The replaced component is then covered with new filler material which adheres perfectly to the previous material. Composed of bicomponent rubber with no shelf life and insulating and resistant to UV rays and ageing.

Product	Description	Rubber colour	Total quantity (ml)
Galactic Protection	bicomponent rubber	●	300

## Installation sequence

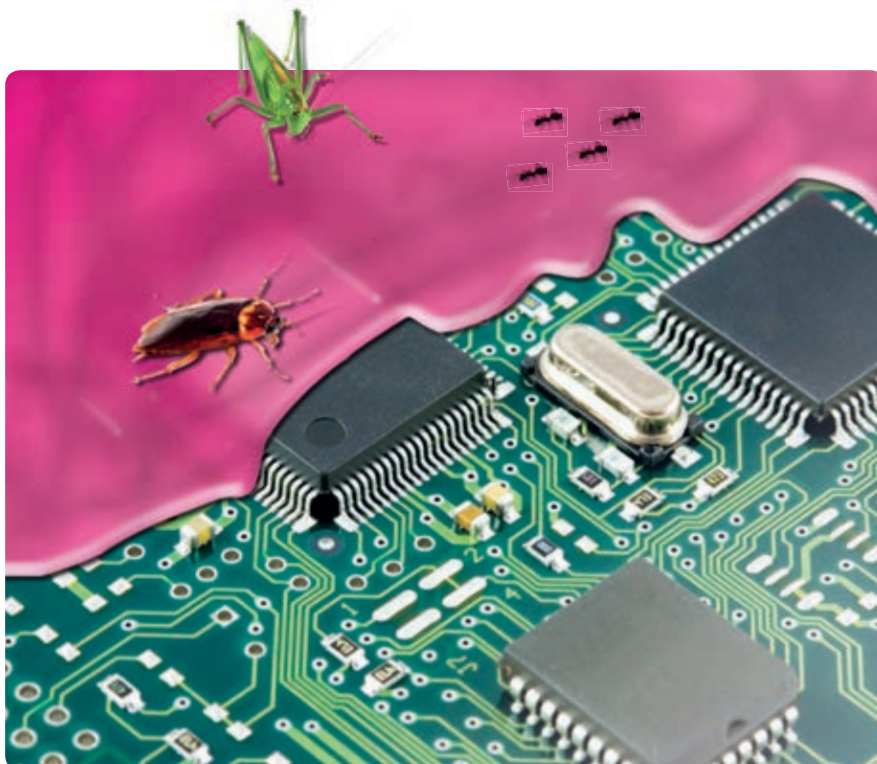

### Kit composition:

2 vials bicomponent product



# Galactic Animal Barrier

Mouldable bicomponent rubber paste to prevent animal intrusion.

Galactic Animal Barrier is a bicomponent paste with no shelf life that can be easily be moulded before cross linking is complete. It can be applied to entries to protect against intrusion (conduits, cable ducts and pipes etc). It cross links quickly to form an effective barrier against small insects however it is easily removable. Ideal for electric gate type installations.



**Kit composition:**  
2 cans (bicomponent)

Product	Description	Rubber colour	Total quantity (g)
Galactic Animal Barrier	bicomponent rubber	●	250

## Installation sequence

2 minutes max

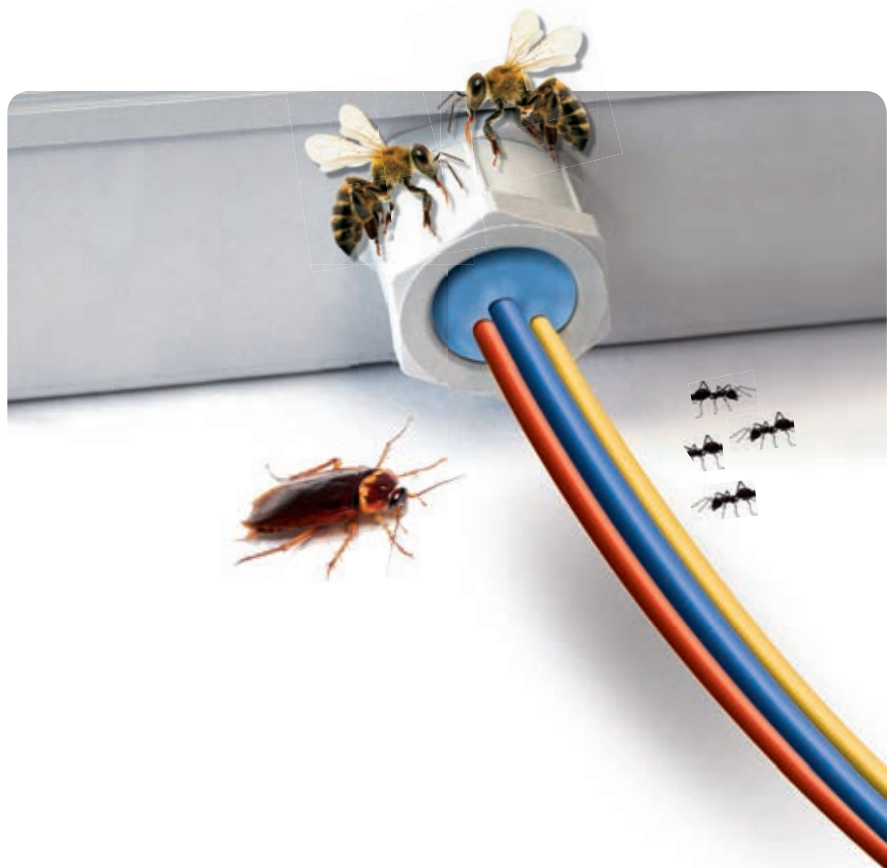



# Galactic Water Stop

Ready to use single component gel.

The Galactic Water Stop single component gel is a soft, extremely sticky product supplied in convenient, ready to use packages: just tear open the quantity needed and place it at the entry point to protect from infiltration. Thanks to its stickiness, it provides stable and effective sealing over time. Easily removable and re-enterable, allowing repeated access to the protected component without leaving traces. Non-drip so it can also be installed vertically or on the ceiling. Highly sealant, lends itself to the insulation of small connections, or for the protection of particularly exposed connections (connections to external car battery terminals, etc.). This product can be applied wherever there may be leakages from pipes, corrugated pipes, channels, etc., or where there is a need for rapid and efficient insulation.

Product	Description	Gel colour	Package (g)
Galactic Water Stop	single component gel	transparent	2 x 100

## Application example



Corrugated pipe entry protection



Removal



**Kit composition:**  
2 cans, 100 g each



**Kit composition:**

3 complete Galactic NanoJoint

**Electrical performance:**

CEI EN 50393 as applicable  
(testing under water head of the accessory installed in a box)

# Galactic Nano Joint

Pre-filled straight and branch single pole joint complete with lever arm connector.

Single core gel joint for straight and branch connection for insulated cables and conductors up to 4 mm<sup>2</sup>, complete with snap connector: simply strip the conductor and close the casing.

- Safe, quick, non-toxic, re-enterable
- For submersible use
- Connector with voltage detection window
- Connections without crimping or screws

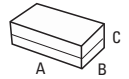

Product	Cable formation (n° x mm <sup>2</sup> )	Dimension A x B x C (mm)
Galactic Nano Joint 4	1 x 0,08 - 4	61 x 35 x 28

### Installation sequence

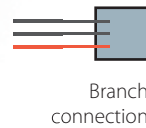
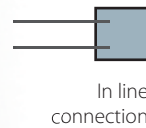
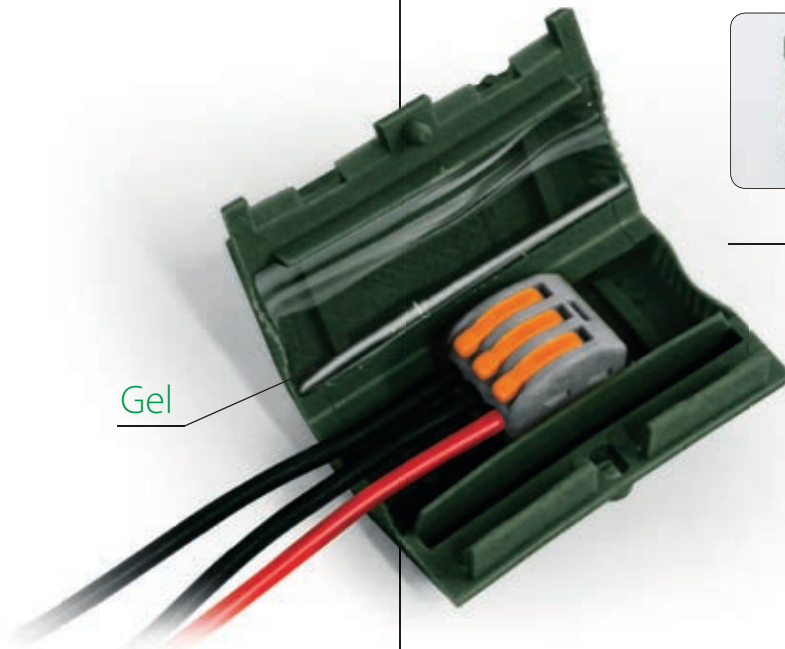

# Galactic Separator

Spacer and connector kit.

Kit includes 5 pole separators, 5 screw connectors and a roll of insulation tape. Once installed the connectors are separated by the wrap around casing. They can then be used in any enclosure which can be filled with Magic Gel, Ray Gel, Magic Rubber or Ray RTV.

Product	Maximum conductor cross section (n° x mm <sup>2</sup> )
Galactic Separator 6	5 x 1 a 6
Galactic Separator 16	5 x 2,5 a 16

Galactic Separator 6

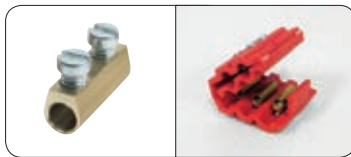

Galactic Separator 16

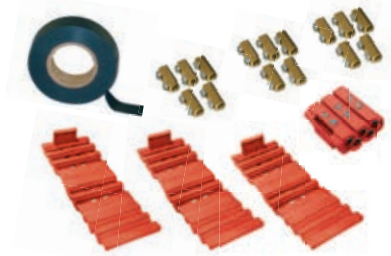
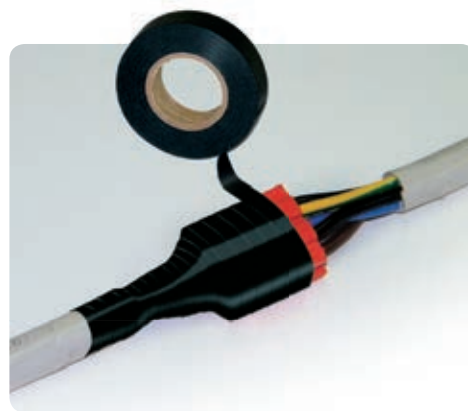

### Galactic Separator 6:

- 6 wrap-around separators (red) for connections up to 5 conductors
- 30 x 6 mm<sup>2</sup> screw connectors
- 1 Rayteam tape

### Galactic Separator 16:

- 3 wrap-around separators (grey) for connections up to 5 conductors
- 15 x 16 mm<sup>2</sup> screw connectors
- 1 Rayteam tape

# Galactic Cleaner

Extraordinary detergent for all types of use.

Extremely effective, able to remove grease, encrustations and smog without damaging the surfaces on which it is applied. Wipe glass with a dry cloth. Do not apply to painted sheet metal.

- For many applications, cleans, de-greases, protects
- With excellent results even in impossible conditions

Product	Description	Quantity (ml)
Galactic Cleaner	Spray bottle	750

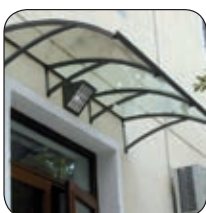

### Mode of use:

spray the product, leave a few minutes, rinse or remove with a cloth.



# Ray RTV

Fast cross linking bicomponent silicone rubber with high mechanical, thermal and elastic characteristics.

Ray-RTV cross links quickly at room temperature, transforming into a rubber with high mechanical, thermal and elastic characteristics. Available in single dose bags, bottles, tanks and boxes, in standard 30 Shore A hardness for black and 15 Shore A for pink. Fast cross linking (less than 8 minutes at 30°C) and easily re-enterable

- Highly resistant, non-stick, insulating and sealing
- No shelf life

- Density:** about 1.24 gr/cm<sup>3</sup> (black)  
1.05 gr/cm<sup>3</sup> (pink)
- Cross linking:** (pot life) at +30°C: <8 minutes
- Viscosity:** 4000-6000 max MPas
- Elongation at break:** 350 %
- Tensile strength:** 2,8 MPa
- Operating temperature:** -60°C / +200°C
- Overload temperature:** +250°C
- Thermal conductivity:** 0,2 W/m<sup>2</sup>K
- Dielectric strength:** >21 kV/mm
- Volume resistivity:** >1,5 x 10 exp 15 Ω cm





Installation sequence



In 15 minutes  
**RayRTV**  
is ready!

Applications Examples



Product	Colour	Weight	Shore A hardness	Package type
Bag-RTV 200-N	●	200 g	30	Single dose bag 
Bag-RTV 350-N	●	350 g	30	
Bag-RTV 200-R	●	200 g	15	
Bag-RTV 350-R	●	350 g	15	
Ray-RTV 1000-N	●	1000 g	30	Cans 
Ray-RTV 1000-R	●	1000 g	15	
Ray-RTV 10K-N	●	10 kg	30	Boxes 
Ray-RTV 20K-N	●	20 kg	30	
Ray-RTV 400K-N	●	400 kg	30	
Ray-RTV 10K-R	●	10 kg	15	
Ray-RTV 20K-R	●	20 kg	15	
Ray-RTV 400K-R	●	400 kg	15	

Other colours, hardness and cross linking times (pot life) are available upon request for tanks of 400 Kg. Ray-RTV is available in bags up to 600 g.





Kit composition

- 1 mould for elastic washers, insulating gaskets and rubber profiles
- 2 bottles of two-component liquid rubber

Advantages

Use directly on site, usable in all weather conditions, easy installation, easy separation from the moulds

Note: max thickness: 3 mm



Side A



Side B



# Gasket Kit

Kit to produce rubber gaskets and profiles.

Kit for the assembly of elastic washers, insulating gaskets and rubber profiles, UV resistant and anti-aging, with working temperature up to 200°C and 30 Shore A hardness, suitable for any electrical, plumbing, or sealing work. The articles produced are suitable for the sealing of outdoor lamps, for the sealing and insulation of screwed and bolted components, for any maintenance, replacement or shimming work. Easy to use, the liquid component is poured and the pieces are ready in minutes, at room temperature and with no exothermic reaction. Easily removed from the mould. Rapid cross-linking at room temperature (<15 min). Elevated dielectric, mechanical, elastic and thermal properties.

- Without shelf life and re-enterable
- Low emission of smoke and toxic and corrosive gases
- Flexible and elastic over time

Product	Description	Rubber colour	Package (g)
Gasket Kit	Mould + Bicomponent liquid rubber	●	360

FLAT GASKETS		RODS	PROFILES
Ø External (mm)	Ø Internal (mm)	Ø (mm)	L x L (mm)
30	22	30	130 x 6
25,5	17	25	130 x 5
24	18	20	130 x 4
22	16,5	15	130 x 3
21	15	10	130 x 2
18	12		
14	8		
11	6		
10	7		
8	4		

GASKETS FOR TAPS		ANTISLIP	CORRUGATED
Ø External (mm)	Ø Internal (mm)	L x L (mm)	L x L Ø - hole (mm)
22	4,5	30 x 30	30 x 30 - Ø hole 4,5
15,8	4,5	25 x 25	
14	4,5	20 x 20	
		15 x 15	
		10 x 10	

### Installation sequence



Pour the 2 components in a 1:1 ratio in a beaker and mix.

Pour the product into the desired mould (30 sec max).

Remove the object from the mould.

<15 minutes at +23°C

# Shiny Solar

Solution for solar and photovoltaic panel maintenance.

Shiny Solar is a product for photovoltaic and solar module maintenance, for easy removal of grease, limestone and crystallised deposits, dust, smog, excrement, etc. A photovoltaic panel can reduce generated power by up to 15% for non-polluted areas and 25% for highly polluted areas, Regular use of Solar Shiny keeps systems running efficiently. Extremely effective and easy to apply, with no shelf life. To maintain system efficiency, proceed with 2-3 applications/year for medium-polluted areas. The degreasing and anti-static protection contained in the product allows excellent results even with rinsing with hard water (even higher than 30°F). Rapid application: treatment of a 6 kW system (approximately 50 m<sup>2</sup>), thanks to the fact that degreasing, cleaning and application of the anti-static protection are all part of one single operation, requires less than 20 minutes. Shiny Solar respects panel components, the aluminium frame, gaskets and protective glass. A single package of Shiny Solar can treat installed photovoltaic panel power from 10 to 15 kW, equal to a surface of about 80-120 m<sup>2</sup>. The order data table shows the power and surfaces which can be treated with different packages.

- For easy removal of grease, limestone and crystallised deposits, dust, smog, excrement, etc.
- Contains anti-static protection

Product	Product contents	Efficiency (kW/ surfaces treated per package)	
		Power in kW	Surfaces (m <sup>2</sup> )
Shiny Solar	750 ml	10 - 15	80 - 120
Shiny Solar 5	5 lt	70 - 100	530 - 800
Shiny Solar 1000	1000 lt	14.000 - 20.000	106.000 - 160.000
Shiny Brush SB4	brush microfiber		

## Application example



Spray the product evenly on the solar or photovoltaic panel or on the surface to be cleaned and protected.

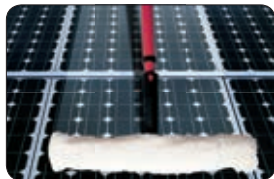

Let stand for a few minutes, depending on the level of dirt to be cleaned, then wipe with a soft, non-abrasive, slightly damp pad or sponge.



Rinse with water or remove product with a paper towel. Repeat for especially dirty surfaces.



## Advantages

The 750 ml and 5 lt kits are supplied together with a professional sprayer, with an adjustable spray jet nozzle with a range in the latter case of up to 3 m.

For proper application of the product even in hard to reach areas, a microfiber brush mounted on a telescopic arm which projects up to 4 m is available.



Shiny Brush SB4



Self extinguishing according to UL94

Halogen free  
Excellent resistance to basis, oils, fats, hydrocarbons, chemicals, chlorinated solvents

Operating temperature:  -40°C / +85°C

Installation temperature:  -10°C / +60°C

## Cable ties

Tilted tip for easy insertion into clamping head. Rounded corners for greater safety. Quick sliding thanks to a low material friction coefficient. Good UV resistance thanks to its black colour.

Essential for:

- Electrical installations
- Industrial applications
- Panels
- Special applications

Colour <b>White</b>	Colour <b>Black</b>	Width (mm)	Length (mm)	Appl. diameter		Strength	
<b>Product</b>	<b>Product</b>			min	max	(Kg)	(n)
Ray-fasc B 22/75	Ray-fasc N 22/75	2,2	75	0.75	15	6.12	60
Ray-fasc B 25/98	Ray-fasc N 25/98	2,5	98	1	21	8.16	80
Ray-fasc B 25/135	Ray-fasc N 25/135	2,5	135	1	32	8.16	80
Ray-fasc B 26/160	Ray-fasc N 26/160	2,6	160	1	40	8.16	80
Ray-fasc B 26/200	Ray-fasc N 26/200	2,6	200	2	52	8.16	80
Ray-fasc B 36/140	Ray-fasc N 36/140	3,6	140	2	35	13.26	130
Ray-fasc B 36/200	Ray-fasc N 36/200	3,6	200	2	50	13.26	130
Ray-fasc B 36/290	Ray-fasc N 36/290	3,6	290	2	80	13.26	130
Ray-fasc B 36/370	Ray-fasc N 36/370	3,6	370	2	103	13.26	130
Ray-fasc B 48/178	Ray-fasc N 48/178	4,8	178	2	45	22.44	220
Ray-fasc B 48/200	Ray-fasc N 48/200	4,8	200	3	50	22.44	220
Ray-fasc B 48/250	Ray-fasc N 48/250	4,8	250	3	68	22.44	220
Ray-fasc B 48/290	Ray-fasc N 48/290	4,8	290	3.5	79	22.44	220
Ray-fasc B 48/360	Ray-fasc N 48/360	4,8	360	3.5	103	22.44	220
Ray-fasc B 48/390	Ray-fasc N 48/390	4,8	390	3.5	106	22.44	220
Ray-fasc B 48/430	Ray-fasc N 48/430	4,8	430	3.5	115	22.44	220
Ray-fasc B 78/180	Ray-fasc N 78/180	7,8	180	3.5	45	55.08	540
Ray-fasc B 78/240	Ray-fasc N 78/240	7,8	240	3.5	63	55.08	540
Ray-fasc B 78/300	Ray-fasc N 78/300	7,8	300	4	80	55.08	540
Ray-fasc B 78/365	Ray-fasc N 78/365	7,8	365	8	100	55.08	540
Ray-fasc B 78/450	Ray-fasc N 78/450	7,8	450	35	130	55.08	540
Ray-fasc B 78/540	Ray-fasc N 78/540	7,8	540	35	158	55.08	540
Ray-fasc B 78/750	Ray-fasc N 78/750	7,8	750	35	220	55.08	540

100-piece pack



## Cable tie support

Fastening with standard inserts for cable ties with widths up to 9 mm. UV resistant.

Product	Dimension (mm)			
	A	B	C	D
Ray-fasc S	9,4	5	23	17,6

100-piece pack

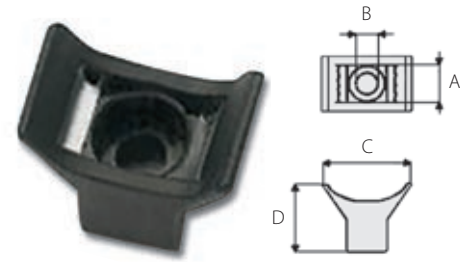

## Bi-Directional adhesive fixing device

Self adhesive, can be used on all materials. Suitable for cable ties up to 4.8 mm. Made from ABS with rubber based adhesive foam. UV resistant.

Colour White	Colour Black	Tie width (mm)	Dimension (mm)				
Product	Product		A	B	C	F	H
Ray-fasc BBA36	Ray-fasc NBA36	3,6	19	4,1	19	4	5
Ray-fasc BBA48	Ray-fasc NBA48	4,8	27	4,8	27	6	6,5

100-piece pack

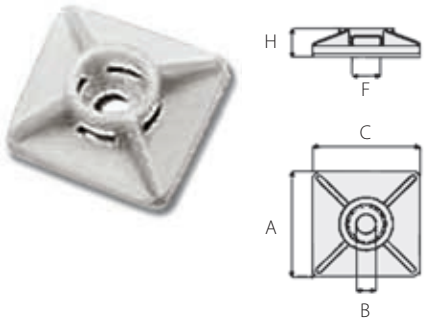

## Bayonet-Joint support

Push fit support for cable ties up to 7.8mm. Can be used on sheet surfaces with up to 3.2 mm thick. 6.2mm O/D hole required. Polyamide 6.6.

Product	Dimension (mm)						Ø Hole (mm)
	A	B	C	D	E	F	
Ray-fasc SI	10	10,6	8,1	3,2	8	7,1	6,2

100-piece pack

